

# AIR STORIES

7<sup>D</sup>

THE ALL BRITISH MAGAZINE OF FACT AND FICTION

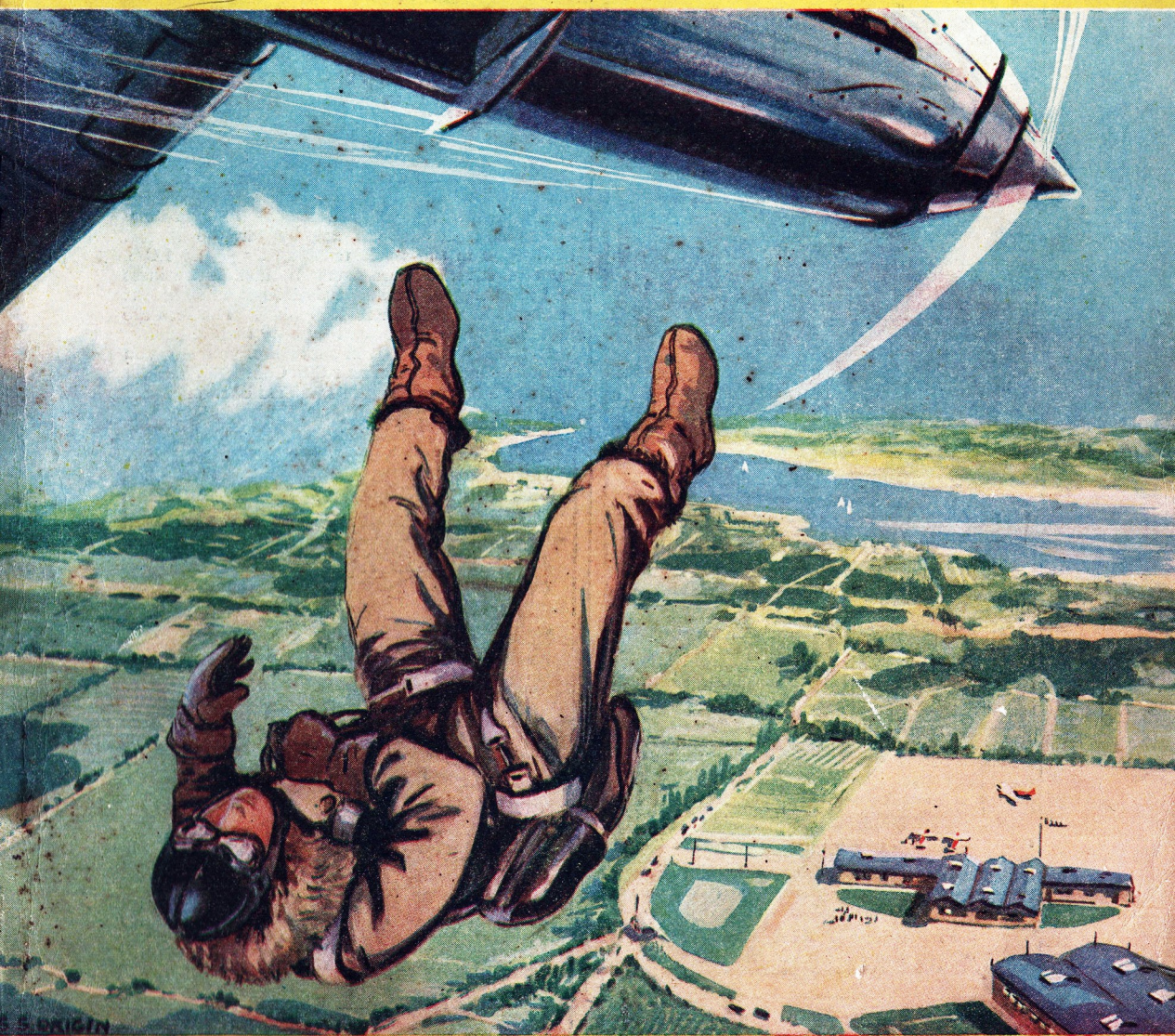

GREAT MODERN AIR MYSTERY STORY  
**THE LOOP OF DEATH**  
BY CAPT. J. E. GURDON D.F.C.

MAY

# RHEUMATOID ARTHRITIS

**NOW CURABLE!**

Also **CHRONIC RHEUMATISM, LUMBAGO, GOUT, NEURITIS, SCIATICA, SWOLLEN JOINTS** and kindred ills.

At last the cure for Rheumatoid Arthritis has been found. To-day those who but a few short weeks ago were crippled

## THE BURDEN OF EXCESS ACID



by the ravages of Rheumatic and Arthritic affection, are fully restored to health. Their pain is banished, their agony ended. Complete freedom of action has returned to them.

First among the recommendations of the wonderful "Curicones" remedy is the support of doctors. Doctors are neither quickly nor easily convinced, and in 1935 over

**4,110 DOCTORS  
PRESCRIBED  
"CURICONES"**

(Figures certified by well-known Chartered Accountants.)

It is the power of "Curicones" to grapple with and conquer the worst forms of Rheumatic and Arthritic affection that has won such unsurpassable testimony.

The harrowing effect of Rheumatic and Arthritic ailments is due to excess acids and poisons. In all of us there is a certain necessary percentage of acid. But in the blood of Rheumatic and Arthritic sufferers this percentage is often double or even more than the normal. Illustration A shows a sufferer under the burden of excess acid. The dark section in the test-tube represents excess of Uric, Hippuric and Lactic Acids which form sharp, dagger-like crystals. These crystals coagulate round the joints and cause appalling anguish.

## FREEDOM REGAINED!

But the invincible action of "Curicones" ferrets out all



excess acids, speedily dissolves the abominable crystals and expels these substances by the natural channels of excretion.

Illustration B shows the results of taking "Curicones"—the dark section in the test-tube portraying the percentage of acid in the blood restored to the healthy normal—some 3 milligrammes per 100 c.c.

## Some of our Distinguished Patrons.

His Grace the Duke of Devonshire.  
Her Grace, Constance Duchess of Westminster  
The Countess of Ravensworth.  
Viscountess Ashbrook.  
Sir Clifford Cory, Bart.  
Sir W. Currie.  
Sir Lancelot Aubrey Fletcher.

## FREE TRIAL

Let the unflinching thoroughness of "Curicones" rapidly rid you of Rheumatoid Arthritis, Chronic Rheumatism, Gout, Lumbago, Sciatica, Neuritis, Synovitis, Fibrositis, Swollen Joints, or some allied complaint. Send the coupon NOW for a FREE TRIAL TREATMENT and a 32-page explanatory booklet. ACT NOW and know again the joys of pain-free, radiant health.

## POST COUPON NOW

To **STEPHEN MATTHEWS & Co. Ltd.**  
Mfg. Chemists and Druggists (Dept. A.S.1),  
19/21 Farringdon Street, London, E.C.4.

Please send Free and post paid Trial Supply of "CURICONES," with an interesting booklet.

NAME.....

ADDRESS.....

AILEMENT.....

PLEASE WRITE IN BLOCK LETTERS

"CURICONES" are stocked by all Chemists. For Free Sample, however, Post the Coupon above.

# I. C. S.

can mean to you



The trade revival has brought Trained Men into greater demand than ever before. Only through training can you succeed in life. I.C.S. Training can strengthen your earning power and place you in line for promotion. It has helped tens of thousands who to-day are occupying good positions and earning good salaries.

Established 45 years ago, the International Correspondence Schools are by far the largest institution in the world teaching by post. I.C.S. Courses cover almost every branch of business and industry, and many professions. The student studies when and where he wishes. The fees are moderate and can be paid by easy instalments.

If you are interested in success for yourself, you should be interested in an I.C.S. Course. Write for our free advice or use the attached coupon.

## COUPON FOR FREE BOOKLET

**INTERNATIONAL CORRESPONDENCE SCHOOLS LTD., DEPT. 65, INTERNATIONAL BUILDINGS, KINGSWAY, LONDON W.C.2**

Without cost or obligation, please send me your booklet of information about the Courses I have marked X.

## BUSINESS AND GENERAL

Accountancy  
Advertising  
Book-keeping  
Commercial Art  
Commercial Training  
French and Spanish  
General Education  
Insurance

Journalism  
Salesmanship  
Scientific Management  
Secretarial Work  
Shorthand-Typewriting  
Short-Story Writing  
Window Dressing  
Works Management

## TECHNICAL AND INDUSTRIAL

Aeronautical Engineering  
Agriculture  
Air Conditioning  
Architecture  
Boilermaking  
Building  
Chemical Engineering  
Civil Engineering  
Dairy Farming  
Draughtsmanship  
Electrical Engineering  
Engineering Shop Practice  
Gas-Power Engineering  
Horticulture  
Heating and Ventilation  
Marine Engineering

Mechanical Engineering  
Mining  
Motor Engineering  
Municipal Engineering  
Patternmaking  
Plumbing  
Poultry Farming  
Radio  
Sanitary Engineering  
Sheet-Metal Work  
Steam Engineering  
Structural Engineering  
Surveying  
Textiles  
Welding, Gas & Electric  
Woodworking

EXAMINATIONS, state which.....

NAME..... AGE.....

ADDRESS.....

ALL ADVERTISEMENTS FOR "AIR STORIES" should be addressed to Advertisement Department  
George Newnes, Ltd., 8-11, Southampton Street, Strand, W.C.2. Telephone: Temple Bar 7760.

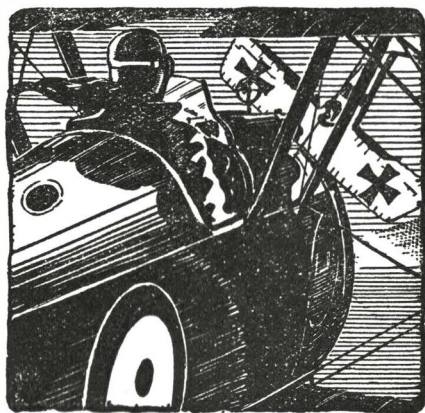

# AIR STORIES

FLYING THRILLS AND  
AERIAL ADVENTURE

MAY, 1936.  
Vol. 2. No. 5.

7d. per copy  
9s. a Year

<b>LONG COMPLETE AIR-WAR ADVENTURE</b>	<b>PAGE</b>
<b>THE MACARONI CUP</b> . . . . . <b>Wilfrid Tremellen</b>	<b>386</b>
Because a London Restaurant was bombed, the "Bloody Stock Exchange" was set up on an R.F.C. 'Drome in France to deal in Shares of Death	
<b>TWO GREAT MODERN AIR THRILLERS</b>	
<b>THE LOOP OF DEATH.</b> . . . . . <b>Capt. J. E. Gurdon, D.F.C.</b>	<b>424</b>
Flight Lieutenant Kinley, R.A.F., Investigates the Affair of the Mysterious Mr. Yen and the Fighter that Wouldn't Stop Looping	
<b>AT FIFTY FEET</b> . . . . . <b>Buckley Roberts</b>	<b>413</b>
Above a Peaceful English Countryside, an ex-war Pilot found himself Engaged in a Duel more Grim than any he had Waged in France	
<b>TWO GREAT AIR-WAR STORIES</b>	
<b>MYSTERY OF THE MARSHES</b> . . . . . <b>Milford Hyde</b>	<b>441</b>
Captain Oswald Sparling, R.F.C., was a Tenacious Hunter, and when he went Wild Duck shooting in England, he returned to France with "The Bird"	
<b>VISIBILITY LOW</b> . . . . . <b>G. M. Bowman</b>	<b>467</b>
A Pilot who Goes out on Patrol in a Biplane and returns in a Triplane is either Exceedingly Unobservant or Extraordinarily Fortunate	
<b>THRILLING AIR-WAR HISTORY</b>	
<b>No. 55 SQUADRON</b> . . . . . <b>W. MacLanachan</b>	<b>463</b>
The Story of One of the Most Famous of British Bombing Squadrons	
<b>SPECIAL AIR FEATURES</b>	
<b>AEROPLANES OF THE WAR</b> . . . . . <b>Described and Illustrated</b>	<b>422</b>
<b>MODEL SECTION (The Bristol Bulldog)</b> . . . . . <b>By J. H. Stevens</b>	<b>458</b>
<b>A "CIRCUS" MASTER OF THE AIR</b> . . . . . <b>By A. H. Pritchard</b>	<b>437</b>
<b>AIR BOOKS OF THE MONTH</b> . . . . . <b>Reviews</b>	<b>436</b>
<b>CONTACT</b> . . . . . <b>By The Editor</b>	<b>479</b>

Most of the Original Drawings in this Magazine are For Sale. Terms may be had on application to the Cliché Dept. (AIR STORIES), George Newnes Ltd., 8-11 Southampton Street, London, W.C.2.

Subscription Price to any part of the world, post free, for one year, 9s. (Canada, 8s. 6d.). Registered at the General Post Office for transmission by Canadian Magazine Post. Published by George Newnes Ltd., 8-11 Southampton Street, Strand, London, W.C.2. Printed in Great Britain by The Whitefriars Press Ltd., Tonbridge. Sole Agents for Australia and New Zealand: Gordon & Gotch Ltd. Sole Agents for South Africa: Central News Agency Ltd.

# THE MACARONI CUP

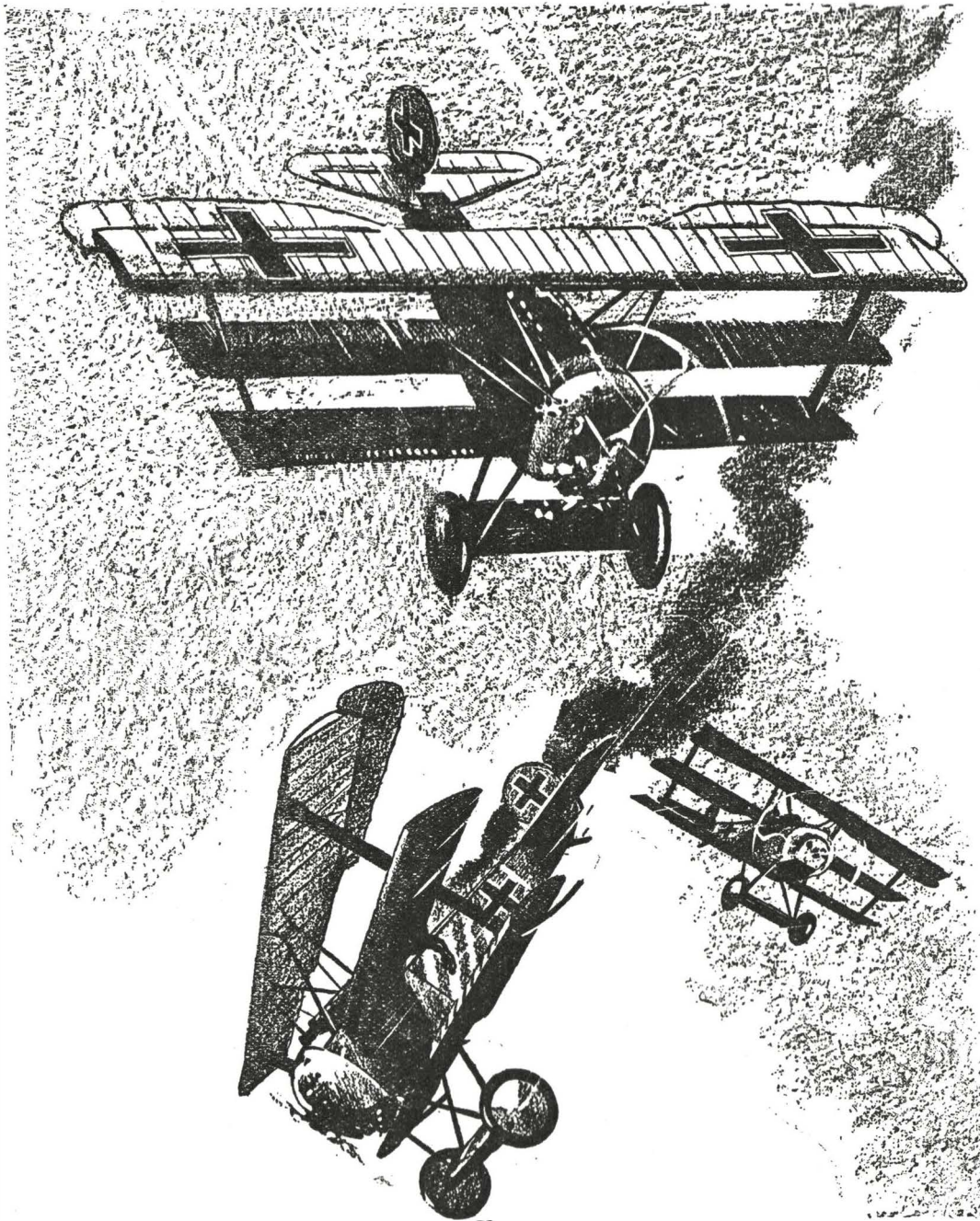

*The second Fokker swerved violently to one side, its engine reduced to scrap iron . . . .*

**A Long, Complete Story of War-time Adventure with the  
Royal Flying Corps on the Western Front**

Because a Zeppelin Bomb Destroyed a Famous London Restaurant, the "Bloody Stock Exchange" was Set Up on an R.F.C. Aerodrome in France and "Fozle-Board" and "Camel" Shares Rose and Fell in Value According to the Daily Fortunes of two British Squadrons, Rivals for that Bitterly-contested Trophy of Death—the Macaroni Cup

By WILFRID TREMELLEN

*Lieutenant R.A.F. (retired)*

CHAPTER I

The Affair of the R.E.8

I WANTED to borrow a pair of goggles. I went up to Rackham of the Camel squadron. "Rackham, old boy, can you lend——?"

He dashed past me, hardly turning his head. "Sorry, old man, I'm in a hurry! It's the first day of the Macaroni Cup!"

"The what?"

But Rackham was off.

I walked over to Stringer, also a Camel merchant, who was climbing feverishly into his Sidcot. "Stringer, old fellow, d'you happen to have——?"

He grabbed up his gauntlets, butted his head into his flying-helmet, and dodged past me. "Sorry, Trevelyan! Macaroni

Cup! I want to——" His voice trailed off into vagueness, as he broke into a double and disappeared from view.

I ran down Sergeant Haystead, a quiet little observer of the R.E.8 squadron. "Good morning, Sergeant. I wonder if you have got a spare——?"

But that decent little man looked so distressed when he looked up from collecting his gear that I got no further.

"'Morning, sir. 'Fraid my pilot's waiting for me. Everybody's in a hurry to-day. It's this Macaroni Cup, you know."

I was just moving over to my own hangar when "Tiggy Wiggy" (Major Tignell-Wingate, C.O. of my own squadron, the S.E.5's) came bustling by.

"'Morning, Trevelyan."

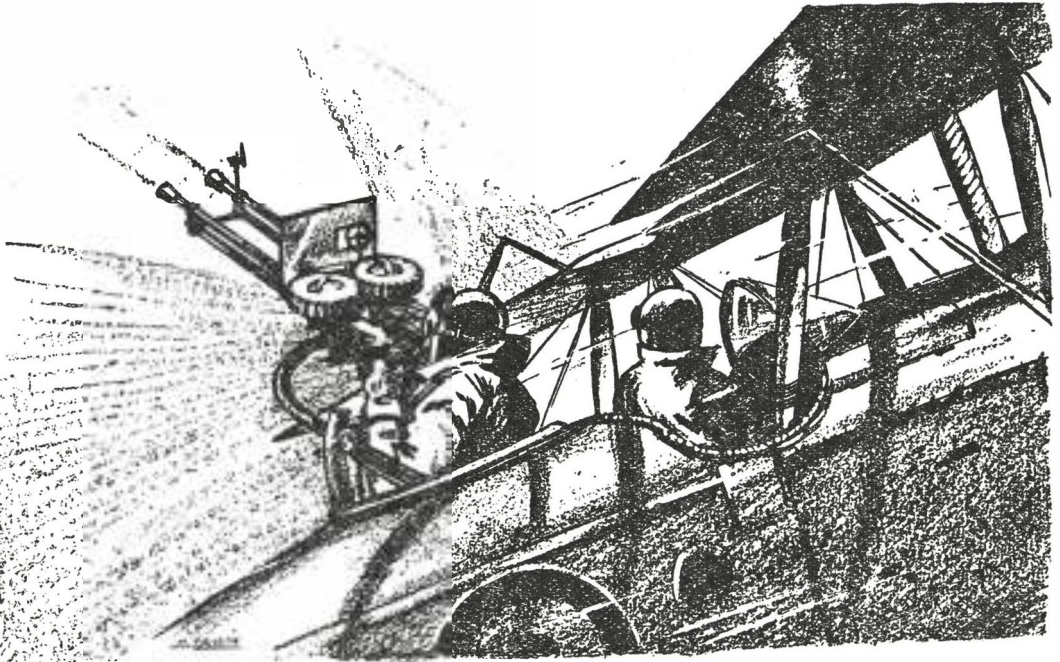

... by the punishing stream of fire from the twin-Lewises of the crouching observer.

## AIR STORIES

"Good morning, sir."

He was about to pass by, when he bethought himself and turning back, put a hand on my shoulder. "By the way, Trevelyan, do you happen to know what these lads in the other two squadrons are referring to when they talk about the 'Macaroni Cup'?"

By the time I reached "Woggy" Wane, with whom I was nearly due to begin an offensive patrol, I was just a little tired of the Macaroni Cup. Voices shouted the two words from hangar to hangar; "Macaroni Cup!" "Macaroni Cup!" Groups of mechanics seemed to have no other topic of conversation as one hurried past. "Macaroni Cup!" What the deuce was it, anyway?

Woggy Wane was already arrayed in his Sidcot when I came on him. In answer to my request, he rummaged in his locker and produced what I was wanting. Woggy is the kind of fellow who keeps two of everything, so as to be able to lend. He is the squadron friend-in-need.

"Time we were taking off, my dear," he remarked, strapping his flying-helmet under his chin. "By the way, what's this Macaroni Cup everybody seems to be talking about?"

I didn't mean to be ungrateful, but this was the last straw. I cupped my hands round my mouth and bawled at him an answer that could have been heard down at the Mess.

"WOGGY—I DON'T KNOW!"

**N**OW that sunny September morning when Woggy Wane and I took-off on our S.E.5's to do a common-or-garden O-Pip was the beginning of a nine-day mystery in the three squadrons that shared our aerodrome. The patrol itself was exciting enough, but if I had known then what I came to know later, it would have been a hundred times more interesting.

I didn't know at the time, for instance, anything about the Macaroni Cup; nor that the Camel squadron and the R.E.8 squadron, who shared our aerodrome, were in the throes of a competition of positively cut-throat intensity.

I didn't know that at home in London a Zeppelin had dropped a bomb which completely destroyed the facade of a famous restaurant in Rupert Street—and the extraordinary sequel.

I didn't know, so very much, about Sergeant Haystead; and certainly I was unaware that his wife was ailing.

Again, I didn't know that within a short time the "Bloody Stock Exchange" would be set up in our Intelligence Hut, and that shares would rise and fall in value according to the index of crashes and killings that attended the daily fighting over the German lines.

Lastly, but most important of all in view of the offensive patrol which Woggy and I were just about to begin, I didn't know anything at all about the famous "Fozzle-Board."

Part of our job on that patrol was to keep a friendly eye on the R.E.8 down below. He was doing pretty good work, the observer in that 'bus. A really good man doing artillery-observation is always worth watching, and Woggy and I, flying a couple of thousand feet above his head to keep the Huns from annoying him, were enjoying his exhibition of skill.

The "shoot" being carried out was a little job of counter-battery work; a howitzer-battery, R.G.A., was doing its damndest to demolish its opposite number on the German side of the line, a Hun howitzer-battery that had been a source of great mischief to our men in the trenches. Though skilfully camouflaged, these German guns had been spotted from the air by their flashes at dusk, and a shoot had been arranged for this morning.

It is fascinating to watch—if you keep out of the line of flight of the shells. (Once it was my good fortune actually to see a shell in the air. The point being that the trajectory of a howitzer shell is so steep that there is a moment when the rising missile stops, turns over, and begins to drop.)

We in the air were able to see both batteries but, on the ground, a rise in the terrain prevented either team of gunners from seeing the other. To the British battery, the target against which they were sending salvo after salvo was no-

## THE MACARONI CUP

thing more than a pinpoint on the map. This is good enough for rough work, but for the accurate planting of shells just where most damage can be done something more is needed—an F.O.O.\* with a telephone, or, better still, an R.E.8 flying over the target with a good art.-obs.† man in the back seat. Without this help, the gunners' shooting is rather like the famous game of "Donkey," in which a blindfolded child attempts to pin the animal's tail in the right place.

We watched the salvos of shell-bursts creep nearer and nearer, like blind fingers searching for the luckless German battery. Each burst sent up a tall fountain of earth and débris.

At first it had been difficult for us to spot the actual position of the enemy emplacements, so well were they concealed from prying aircraft. But now some of the camouflage-netting had been blown away, and several dark gun-pits were clearly visible even from our height.

Constantly surrounded by black puffs of "Archie," the R.E.8 flew steadily round in slow figures-of-eight, while with deadly accuracy the observer tapped out on his morse-key the fire-correction for every salvo.

His first reward came a moment later. A complete German gun, looking more or less whole from the distance, suddenly rose from its emplacement, lifted on the crest of a fountain of earth, and turning slowly over on its back, sank back into its gun-pit.

"That's the stuff!" I shouted to the sky at large. "That's the stuff! Give 'em——!"

*Tacca-tacca-tacca-tacca!* A burst of fire behind me and a shrill wail of wires made me jerk my head round. Woggy, who had already banked round, was firing a warning burst.

Then from the eye of the sun there swept down five Huns in a screaming power-dive. Of these, three took no notice of us at all, but continued their dive, making straight for the R.E.8. The other two engaged Woggy and me, tracer darting from their guns.

I realised the situation at once. The deadly fire-direction of the R.E.8 observer had so panicked the German "how." battery that frantic appeals for help had been sent speeding along telephone wires to the nearest aerodrome. The immediate result had been the dispatch of this formation of Fokker triplanes with orders to send the artillery machine down in flames.

It was too late to save the battery, for the observer had already tapped out the M.O.K.\* and the British battery would automatically continue the plastering until the target was destroyed. Already the terrain had been churned into pudding by the blasting H.E.† shells, and in that area nothing could live.

But it was a poor look-out for the crew of that R.E.8, with three Huns to deal with, all diving out of the sun.

I FIRED a hurried burst at my own sparring-partner (a novice from what I could see of his turns) and went yowling down full pelt after the three Huns about to attack the R.E.8. My orders were to protect him; I pushed forward the throttle-lever and shot down until every wire wailed like a banshee. But they were fast, those triplanes.

I was too late to do anything for that R.E.8. I am glad I was. If I had had my eye glued to the Aldis sight in an effort to put a burst through the nearest of the attackers, I should have missed the prettiest piece of gun-play I ever hope to see.

I have already indicated that the observer in the back seat of that artillery machine was an adept at conducting a "shoot" for the gunners. I was now to see that he was a past-master at shooting on his own account. It was positively uncanny, the skill of that Lewis-gunner.

At that time I knew nothing about the Foozle-Board—had never even heard the name. My whole experience up to that time had taught me that when a two-seater was in the situation of that R.E.8—a target for three Huns diving out of

\* F.O.O., Forward observation officer.  
† Art.-obs., Artillery observation.

\* Shells falling "Mostly O.K."—on the target.  
† H.E., High explosive (as opposed to shrapnel).

## AIR STORIES

the sun—then that two-seater might already be considered a write-off.

Nothing of the kind.

To avoid any chance of collision, the diving triplanes had ranged themselves in Indian file as they went screaming down on their victim. The plan was that each pilot should put in a long burst and at the last moment zoom up to make room for his next-behind. They were diving straight down out of the sun. To all intents and purposes the R.E.8 observer was a blind man, incapable of defending himself. If ever two men looked like dead men, it was the crew of that R.E.8. Nothing of the kind.

*Tacca-tacca-tacca-tac!* At a distance of two hundred yards, the Spandaus of the foremost Fokker gave tongue, stopped uncertainly for a moment, and burst forth again. *Tacca-tacca-tacca!*

But simultaneously a long burst of tracer streaked from the twin Lewises of the crouching observer, and that foremost Fokker, his propeller shot to match-wood, knew suddenly that this was not his day. Steepening his dive, he flashed downward to a safer atmosphere. One gone.

Hardly had the twin-Lewis guns ceased to clatter than they broke out again in a long, punishing burst to greet the second attacker.

A pertinacious fellow, this. He kept his Spandaus jickering until the last moment, and then, realising that his engine had been pounded to scrap-iron by the jet of armour-piercing Buckingham that streaked from the Lewises, he banked violently and swept to one side. Two gone.

The third triplane pilot learnt nothing from the misfortune of his friends. In exactly the same way he dived; in exactly the same way he tried to put in his burst; and in exactly the same way he seemed to thread himself on that punishing stream of fire that broke from the Lewises, and stay threaded.

It was a stricken triplane that zoomed upwards to avoid collision with the R.E.8—a triplane with no propeller to speak of and no engine to turn it. Helplessly its pilot used the last of his momentum in flipping over in a loop. A defeated man,

no doubt he hoped to spin downward out of the combat and live to fight another day.

But that consummate artist in gun-play who occupied the back seat of the R.E.8 had no further enemy to occupy him and gave the German no chance. His own pilot having banked round to give him a beam shot, he wrenched round his gun-mounting, and as the triplane swept head-long downward, the Lewises seamed it with a long neat row of stitches that stretched from prop-boss to tail-skid. To judge from the way that triplane spun downward, the pilot must have received his full share.

**N**OW all this destruction, which takes so long to describe, took place in a matter of seconds. In the air the manoeuvres of combat have the swiftness of a fast game of squash-rackets. I had witnessed the whole drama in less than a minute.

Diving along the same line of flight as those German triplanes, I had no wish to be mistaken for a fourth attacker by that redoubtable Lewis-gunner. I banked round therefore, and pretty smartly.

I was not sorry to turn anyway, because the Hun "Archie" batteries, infuriated by the easy way in which their three triplanes had been disposed of, were subjecting the R.E.8 to a bombardment of terrific intensity. The air was thick with venomous, pitch-black bursts mushrooming out into harmless grey smoke, and the continuous crashing cough of the explosions convinced me that this was a good section of the sky to get away from. It was the kind of bombardment that made you want to draw your knees up to your chin and long for the days of iron-clad aeroplanes; canvas and wood are not good enough, you decide—no stopping power.

But I was late with my get-away. A sudden shattering explosion that seemed to rend the firmament sent my machine shooting up like a cork with a suddenness that nearly sent me through the floor. It was accompanied by an ominous *tunk!* that sounded very near. At the same time the whole engine began juddering as



## THE MACARONI CUP

though at any moment it would shake itself off its bearers.

Then the propeller stopped — not healthily flicking over a few compression-strokes and quivering to a halt. It stopped dead, with the unmistakable finality of a seize-up.

In the eerie silence that followed, I instinctively put my nose down and removed my left hand from the useless throttle-lever. I knew what had happened ; a fragment of " Archie " shell had penetrated a cylinder-wall.

" Can I get back ? " That was my first thought. You can glide a mile for every thousand feet of height if you are careful, I remembered. Could I get back across the Line ? Yes ; easily.

It was while I was craning my neck over the side of the cockpit that the familiar *tacca-tacca-tacca* broke out behind me and the little darting points of light that are tracer bullets came whizzing past my ears. Devil take it !

Whipping my head round, I saw my original sparring-partner had dropped down for what he thought would be a mouthful of easy meat, curse him !

Now, I had not forgotten that gentleman in my anxiety for the R.E.8. I had given him an occasional glance over my shoulder and I had observed that as soon as he saw the fate of his three friends, he had sheered off, deeming that the vicinity of such a redoubtable observer must be distinctly unhealthy. But the helpless condition in which I was at present had proved too strong a temptation, and now he was coming down to pick up his winnings off the table. Why not ? Fortune of war.

As for me, it seemed best to throw myself into a spin and go on spinning until I reached the ground. I might then do a pancake-landing somewhere soft and make a run for it. In any case it would not be long before I was a prisoner.

But at the moment when the first bullets came whistling past, I happened to have my eye on the R.E.8. It had just finished its shoot and was diving for home to get out of the " Archie " barrage.

At the first sound of firing, its sporting pilot had banked round, and now he was waving his arm and beckoning to me.

Clearly it was an invitation of protection. " Bring that triplane along here," that beckoning arm seemed to say. " Bring him right along ; we keep just the right kind of biscuit for tripehounds ! "

So, giving up the idea of spinning, I put down my nose and made for the R.E.8, flicking over in a few rolls to put the Fokker man off his aim. He was a fool, that triplane pilot ; if he had withheld his fire until he was riding my tail, he could have had me as dead as pressed beef before I realised I was being attacked.

As things were, in a few seconds I had lured him within the zone of fire of the observer in the R.E.8. Even then that foolish tripehound persisted in worrying me.

A long burst from the twin Lewises settled him once and for all. His dive steepened as he slumped forward over the stick and, as he shot downward, a long streamer of dark smoke issued from his cockpit—a streamer that was tinged with orange at the source.

Can you beat it ? In the space of five minutes that miracle-man in the back seat of the R.E. had accounted for no less than four of the latest triplanes of the Imperial Air Service ! Who was he ? And how had he done it ?

AS the R.E. flew alongside to escort me back across the Line, I waved grateful greetings to the occupants, and it was then that I recognised, chiefly by his size, the little man in the back seat.

Sergeant Haystead of all people ! So that pocket-genius of a machine-gunner was our quiet, thoughtful, unassuming little Sergeant Haystead—who was nearly old enough to be my father !

I was astounded. I had known him to be an observer that two-seater pilots respected, and I had known that he was *persona grata* with the gunners as being a level-headed reliable fellow at conducting a " shoot " under harassing conditions, but I had never dreamt that he was such an adept at dealing with tail-riding Fokkers. The man had probably set up an observer's record. How he had been able to look straight into the eye of the sun and thread those three triplanes one

## Introducing the Fozzle-Board

after another on his stream of fire was a mystery that exercised me greatly as I glided back. It was equally puzzling that all three of them should have missed such an easy target as the R.E.8. Had he got hold of some gadget? The memory of certain rumours came back into my mind. There must be something to account for such gun-play.

As I sank gently down to our aerodrome with the wind souging through the wires, I smiled to think that four smart young bloods of the Imperial German Air Service owed their downfall entirely to our unassuming little Sergeant Haystead. Unassuming, yes—but what a gunner!

Up till then our acquaintance had been limited to occasional meetings in the Intelligence Hut, which was common to officers and flying N.C.O.'s of the Three Squadrons, as we called ourselves—the Camels, the R.E.8's and the S.E.5's, to which Woggy Wane and I belonged. I had taken to him at once. To a world that spoke of nothing but crashes and killings and "flamers" and "break-ups," he brought the atmosphere of the sane, respectable, pre-war world. I enjoyed talking to that little man with the philosophic outlook, and in some queer way felt better after doing so.

In build he was small but stocky; in age, about forty, which is old, in the air, even for an observer. He wore his sandy moustache close-clipped, and his blue eyes were at once humble yet fearless and steadfast. "A jolly decent little man," people had said in my hearing; "a good little observer, thoroughly reliable," and—more obscurely to me at that time: "For any job that means working in metals, you can't beat him."

In 1908 he had taken up the comparatively new profession of chauffeur and for five years had driven his old mistress round the countryside in a Daimler to pay her afternoon calls. (It was a maiden aunt of Woggy's, I afterwards found out.) She died a year or so before the war began, and Haystead had gone to London as chauffeur to someone else. But about this job he was silent; I gathered it was not altogether satisfactory. He had joined up in September, 1914.

BY keeping my glide as flat as I dared, I managed to clear the hedge and land on the edge of the aerodrome. Two or three ack-emmas were already racing towards me. Without waiting for them, I dropped stiffly down from the cockpit and walked over to where the R.E.8 had landed.

Sergeant Haystead was returning for his tackle after seeing his pilot into the ambulance car. It seemed that poor Haslett, who had been so sporting in coming to my rescue, had stopped a fragment of "Archie" with his thigh in crossing the Line.

"It's no more than a flesh wound, sir," Sergeant Haystead explained. "It's the bleeding I was afraid of."

I shook him by the hand and gave him my heartiest congratulations on that marvellous feat of marksmanship. "Without you I should have been still in Hunland, Sergeant—dead or alive."

He smiled his pleasure, but said not a word about himself. Instead, he put one foot in the mounting-step of the R.E., reached inside and brought out the pale green canvas hold-all in which observers keep the spare parts of their Lewis guns. This he threw on the grass. Then, reaching down again, he brought out his map-board and, rather to my surprise, proceeded to draw over it a cover specially made from the same pale green canvas as the hold-all. This was done while he was still perched on the mounting-step and was partially concealed from me.

It all seemed rather mysterious, because nobody took much care of maps, they could be had for the asking, and as for map-boards, they were just pieces of ordinary three-ply on which the map was kept in place with rubber rings snipped from inner tubes. Why the special green canvas case then?

As we moved over to the Intelligence Hut to fill in our reports, he tucked the thing carefully under his arm and, as he did so, I noticed that protruding from the map-case were two metal rings fitted with screws.

## THE MACARONI CUP

"You seem to take great care of your map-board, Sergeant," I said, smiling. "Did you make that cover yourself?"

He looked at me quickly, but there was no distrust in his blue eyes. He, too, was smiling.

"Yes, sir, but there's something else besides a map-board in here; there's a fozzle-board."

"A what?"

"A fozzle-board, sir."

"And what may a fozzle-board be?" I queried blankly, and then, struck by an inspiration: "If it's something that enables you to bring down four Fokkers in five minutes, I'd like very much to have a look at a fozzle-board."

For a moment he seemed to hesitate, then he caught sight of a strange officer walking towards us and that decided him. He thrust the thing back under his arm.

"Do—do you mind waiting until after the Macaroni Cup, sir?"

That Macaroni Cup again! But I had no time to ask about the confounded thing, because the tall dark officer was approaching with the evident intention of speaking to me.

"Who's this?" I murmured, eyeing the stranger.

"Name of Landring, I think, sir," said the Sergeant softly, and edging with averted face past the newcomer, dodged into the Intelligence Hut.

**T**HE latest arrival was one of those tall, haughty, unbelievably handsome creatures with scornful eyes that look at you as though you have just elbowed your way up from the bottom of a piece of gorgonzola. You don't see so much of them nowadays; the ones that are not selling motor-cars in Great Portland Street have all gone to Hollywood. This one was dressed in a G.S. tunic with the badges of a good Line regiment, and on his head, with the chin-straps hanging loose, was a flying-helmet of beautifully smooth red leather that simply shouted of Bond Street and the shops that sell ladies hand-bags from 25 guineas a time. Dressed like that, he was *the* answer to the maiden's prayer—Apollo with pilot's wings. A nearer approach

confirmed my suspicions; he used scent on his hair.

He extended a beautiful hand, not nearly so soft as I expected.

"Ah, my name is Thirlmere," he told me in the throaty voice affected by the hot-air fraternity. "I've been posted to the Camel squadron." I breathed a sigh of relief.

"Mine's Trevelyan. I'm afraid I can't be of much use to you then; I'm in the S.E.5's."

In the course of conversation, which on my side, I am afraid, was very perfunctory, I gathered that he had been transferred from another Camel squadron some distance away; that he had brought down seven Huns ("so far," as he negligently added); that his M.C. "ought to be coming through at any time now"; that he expected to have no difficulty at all with the Huns on our part of the front; and, in short, that he was the very deuce of a killer-man.

"What I am looking for at the moment is a free 'bus," he told me in conclusion. "I've just reported to my C.O., but he tells me there is no Camel available. Do you know where I could scrounge an S.E.5?" I didn't.

He turned away. "This competition that begins to-day makes one want to get into the air at once."

I turned round with my fingers on the handle of the door of the Intelligence Hut. At last here was someone who could explain about this confounded Macaroni Cup business.

"What competition is that, Landring?"

Now I hadn't meant to get the fellow's name wrong, but when Sergeant Haystead had told me that his name was "Landring," I had mentally registered it as "Landring," and "Landring" stuck in my memory.

But from the way that man whipped round at me, it might have been the deadliest insult that I had shouted after him.

For a moment we stared at each other; he, startled and angry-looking, I, not realising at first what I had done.

Then, full of confusion, I stumbled up

## AIR STORIES

the steps of the Intelligence Hut and shut the door. It was one of those unsatisfactory incidents that leave one feeling a fool. I didn't want to hurt the man's feelings, but it seemed unnecessary to explain.

But why on earth should Sergeant Haystead have said that a newly-arrived officer's name was "Landring" when it was "Thirlmere"? He seemed to just hate being called Landring!

The morning seemed to be full of mysteries. In a thoughtful frame of mind I filled in my report and threw it in the tray. One thing, I told myself, I must find out about at once, it was beginning to get on my nerves—this Macaroni Cup.

**A**CCORDINGLY, I seized the first opportunity to corner Teddy McFane. Teddy makes it his business to know everything about everybody. If you want to know which Major of the Three Squadrons was the first to get married, or which of the nine Captains has the largest overdraft at Cox's Bank, you have only to ask Teddy McFane. Teddy will then flick over a few pages of his vast mental card-index system, turn up the right fellow, and give you the answer out of hand.

I found him alone, leaning against the bar. There was an intent expression on his face and his eyes were flickering intelligently from time to time as he followed a highly circumstantial narrative with which the Mess Corporal was favouring a mess-orderly behind the screen.

"He's going to divorce her," Teddy murmured to me behind his hand. "Thought he would."

"Who's going to divorce whom, you Juggins?"

"Mess Corporal's going to divorce his wife," returned Teddy in a hoarse whisper. "He's just come back from leave. Caught her at her old games again."

I took him by the arm. "Never mind about the Mess Corporal's troubles. Tell me about this Macaroni Cup."

Teddy finished his drink and then stared at his glass as though he had never seen an empty one before. I rang for an orderly.

"You've come to just the right bloke," Teddy said, sinking into an armchair. "I'll begin at the beginning." (Teddy is a confirmed beginner at the beginning; it's no use trying to stop him; he can't tell you who won the Derby without beginning with the information that the horse was sired by "Spinach" out of "Saucepan.")

"Well," said Teddy, settling down; "there was once a young Eye-talian, named Ravignotti, and he came to England——"

"Wait a minute," I interposed. "Is this one of the two brothers Ravignotti on this aerodrome?"

Teddy hates being interrupted. "No, it's not," he said coldly. "This is their grandfather I'm talking about——"

I groaned.

"——and he came to England in 1886, bringing with him——"

I leaped to my feet, snatched Teddy's glass and held it threateningly over the stove. "The Macaroni Cup I want! Come to the point or——!"

"But it is on the point!" Teddy expostulated. "Every word of it! Gimme my drink!" I let him get on with it.

"Well, when this bloke Ravignotti came to England in 1886 he brought with him his only son, Giuseppe, a nipper of twelve. After that he sat down and died—soon after anyway—but not before he'd got the kid a job in a restaurant."

"What the deuce did you mention him for if he died?"

"To show how the kid became a 'norphan,' of course. Well, this kid Giuseppe didn't get much of a break in the restaurant—not to start with; his job was washing up the dirties and shoving the leavings from the customers' plates into the stock-pot for soup—those that didn't look clean enough to scoff on the spot. Another of his jobs was to collect the odd bits of bread from the tables and keep 'em for future reference—meaning bread-and-butter pudding. Then in his spare time they put him on to throwing dust over the bottles of port, an' garnishing 'em with cobwebs to make 'em look old and crusty——"

## THE MACARONI CUP

"Oh, get on," I said crossly.

"His next job," went on Teddy, quite unruffled, "was in the restaurant itself. You've no idea how sweet he looked with his little white apron reaching down to his little boots——"

"No, I haven't," I said grimly. "Get on."

"He did well at this, because he was deft at service—and defter still at pinching the tips from under the plates before the waiters——"

I made a movement to go.

"*Waida-minute!*" Teddy clamoured. "Well, as he grew older, he went on bettering and bettering himself till at last he became *trancheur*, which is the bloke who does the carving—and divides chickens into portions so that nobody ever gets a wing. It was at this period of his life that his two sons were born—within a year of each other, two big, bouncing boys——"

"You mean our Ravignotti brothers?" I asked with a faint return of interest. "They've still got the bounce, I admit, but as for health—they've gone sick every day since they arrived!"

"Don't be so hard on the near-white races," Teddy reproved. "It's true that neither has crossed the line since they joined their respective squadrons, but then one is suffering from pilot's palsy, and the other from observer's ear-ache. Besides, remember what the old M.O. said."

"What did he say?"

Teddy thereupon seized himself by the left ear and, leaning forward, screwed up his face in a passable imitation of Major McGregor, our fierce old medical officer. "Ma boyeee, ye may make a silk purr-r-rse out of a sow's ear-r-r, but ye'll never-r-r make a soldier-r-r out of the aver-r-r-rage Italian."

"But to return to the revered parent, Giuseppe Ravignotti, his affairs prospered to such an extent that——"

I leaned forward. "You're not going to tell me that he is *the* Giuseppe, the proprietor of that colossal place in Rupert Street!"

"The same fellah." Teddy fumbled in his pocket and produced an immense

pocket-book, from which he extracted a woolly-edged newspaper-cutting comprising text and photograph.

THE photograph portrayed the ruins of the famous *Giuseppe's* in Rupert Street, and standing in front of the shattered facade of the building was the round little, fat little figure of Giuseppe himself. The oily smile on his face was by no means in keeping with the desolation that formed his background.

"A Zepp. bomb did that," Teddy explained, "and the reason why Giuseppe is looking so pleased is that he's fully insured—and anyhow intended to move to a smarter quarter."

I handed back the cutting. "Well, what about this Macaroni Cup?"

Teddy winked. "Well, you see, my dear Trevelyan, Giuseppe is taking over another restaurant, a larger and more splendiferous restaurant, the sort of place that has a Russian *émigré* archduke for head-waiter, and where all the ordinary waiters have to pay premiums for the privilege of plundering the customers, you know. But, meanwhile, he has to keep his name before the public eye. So what better scheme than the Macaroni Cup? Mind you, that's what *we* call it. *He* calls it 'Giuseppe's Vengeance,' or some such high-falutin' name. The idea is that honest Giuseppe is so consumed with hatred of the Huns for bombing defenceless London—meaning Giuseppe's Restaurant—that he is offering a prize of £1,000 and a gold cup to the pilot or observer who destroys the greatest number of Huns in the space of three months, starting from September 1st, to-day. I tell you, these Wops do things on the grand scale—not that he can't well afford it. He must have made three fortunes since the war began—just out of blokes like you and me who go home on leave and take our girls out to dine at *Giuseppe's*."

"So he's offering blood money as an advertisement, the vulgar brute! But, tell me, why haven't I heard about this?"

"Because, my dear fellow, you don't come in on this; the competition is restricted to the Camels and the R.E.8's."

## AIR STORIES

“Why?”

“Because Giuseppe’s *bambinos* happen to be in those squadrons of course. Little Enrico is a pilot in my crush, the Camels, and little Giovanni is an observer in the R.E.8’s.”

“Oh, so that’s it,” I chuckled. “Well if Giuseppe hopes to keep his money in the family, he’s in for a disappointment. Enrico and Giovanni—Lord! What a pair of lead-swingers! By the way, who *is* going to win this Cup?”

“I am,” answered Teddy promptly. “Got a Hun first patrol this morning. I’m a ‘one-er’ already.”

“You know about Sergeant Haystead?”

Teddy’s eyes flickered. “Yes, he’s a ‘four-er,’ but it won’t last. That was a fluke. Observers don’t stand a chance. A Camel will get it.”

“What about this new fellow, Thirlmere?”

“He’s come with a hell of a reputation,” Teddy admitted, “and there’s an M.C. in the offing for him—so he says—but—”

“Teddy,” I said suddenly. “There’s something else I’d like to ask you.”

Teddy stretched luxuriously. “Tell you anything about anything,” he volunteered. “What is it?”

“D’you know what a ‘foozle-board’ is?”

“A what?”

“A fozzle-board. It’s some sort of a gadget, I think.”

But the omniscient Teddy shook his head slowly from side to side.

“Never heard of it. Can’t be much use.”

### CHAPTER III

#### Extra Patrols

**E**XTRA patrols!

The next three weeks were a period of unparalleled activity in the other two squadrons on our aerodrome. Extra patrols were the craze. “Please, sir, can I take up XY 5061?” Extra patrols!

And although the fine weather suddenly ceased and leaden September skies

cast a gloom over everything, at almost every minute of the day a shattering roar would break from somebody’s engine that was being started up, or else the air would be filled with the souging of wires as some pilot or other, his machine riddled with bullet-holes, came gliding in with his tale of victory or frustration. The Macaroni Cup! Extra patrols!

Cursing and sweating, the mechanics worked all night in some cases, riggers replacing splintered struts, sailmakers patching canvas, and fitters tending over-worked engines.

Pilots and observers, white and drawn with the strain of constant combat, would turn in as soon as dinner was over and sleep like dead men till the morrow. Extra patrols!

“Really, my dears!” Leaning against the door-post of the ante-room one evening, Woggy Wane watched a formation of three Camels go streaking across the aerodrome and rise screaming to clear the further hedge; an extra patrol begun within half an hour of sunset. “Really, my dears! Must those children across the way *always* be playing with their flying-machines. It’s not safe to walk across the aerodrome these days.”

Finnigan, in the midst of the poker school, looked across at Woggy, his hand poised to throw down a card.

“I suppose you know *why* those three Camels have just taken-off, Woggy?” he said earnestly.

Woggy turned his head. Other people turned their heads.

“No. Why?”

“You don’t know why those three Camels have just gone off!” persisted Finnigan incredulously.

“No. Why?”

“It’s an extra patrol,” explained Finnigan gently, and threw down his card. A chorus of groans greeted this misguided attempt at wit.

“What’s the betting?” somebody asked.

“Thirlmere of the Camels is favourite—brings down about three Huns a week. He’s two up on anybody else at present.”

“What about Sergeant What’s-his-name—the fellow with the mysterious

## THE MACARONI CUP

gadget? Didn't he bring down four in one day?"

"Oh, the fozzle-board merchant? That was just a fluke; he's never done a thing since then."

"What is this thing he's got, anyway?"

"Tcha! Nobody knows—'cept that it doesn't work."

"It did once. You can't bring down four Huns in five minutes by putting salt on their tails."

"He doesn't stand a chance for the Cup anyway—none of the R.E.8 people do; it's a snip for the Camel merchants."

"Well, I may be wrong, but I've got an idea that we haven't heard the last of that fozzle-board."

"Tcha! Those gadgets never function when you come to put 'em into practice."

But not everybody in our squadron treated the contest of the S.E.5's and the Camels with benevolent neutrality. The grim, forthright Captain McCrail of "A" Flight was vitriolic on the subject of the Macaroni Cup. The idea that extra patrols should be undertaken in the hope of worldly gain called forth his most freezing contempt. "Follow me, 'A' Flight," he growled on one occasion to his pilots. Those unfortunate gentlemen were just trooping out of the Intelligence Hut after filling in their reports of an arduous patrol they had just done. They looked at him astonished.

"Where're we going, Skipper?" asked one.

"Extra patrol," snarled McCrail, "without any tin cups to encourage us."

And half an hour later, spotting a circus of thirty or more Huns, at the head of his formation of S.E.'s he charged down full tilt at them, with such concentrated fury as to scatter them to the four winds. Then, re-forming, he banked round and charged through the astonished circus again. Four of the enemy were accounted for and, what was more important, he brought back all his pilots alive—just.

When they got back to the aerodrome, there was a Camel captain standing about, who eyed the scrap-heap condition of the S.E.'s with mild astonishment.

"Hallo, McCrail, where have you been—extra patrol?"

McCrail, who was helping a wounded pilot out of his cockpit, turned his head. "No!" he snarled. "We've been to fetch the washing—can't you see?"

But on the whole the senior officers realised that it was not the Cup, but the competition, that was the chief attraction. Personally, I had no strong feelings about it at the time. Later I was to be as passionately interested in the fate of that Cup as anyone else.

That was when the whole complexion of the business was altered by particular circumstances, though. In the special circumstances of this case even the granite-souled Captain McCrail came to admit that the Macaroni Cup might not be entirely without its uses.

In fact, there came a morning when McCrail stopped me on the steps of the ante-room and enquired, almost eagerly, "How's he getting on? Think he'll win it? Good! Good! Good!"

"It" was the Macaroni Cup, and "he" was Sergeant Haystead.

**I**T was on the fifteenth day of the contest that the weather changed for the better. The morning was cold, but bright and sunny.

On the early patrol, another Hun fell to the guns of Sergeant Haystead. It had dived on him suddenly, interrupting his art.-obs. work, and had paid the penalty by spinning out of the fight with a propeller shot to matchwood.

A ripple of excitement went round the Three Squadrons. The exquisite Thirlmere and the humble little sergeant were neck and neck, with five Huns apiece.

Meanwhile nobody, least of all Teddy McFane, had lost faith in his own prowess, and the order of the day was as before: extra patrols.

## CHAPTER IV

### A Company is Floated

**W**HAT does Woggy Wane want?" Several voices wanted to know that. "What's Woggy holding conference for?"

## AIR STORIES

There were ten or twelve of us in the Intelligence Hut, all summoned at the instance of Woggy for a particular reason known only to himself and to me.

Looking round, I noted that all present were officers and, though drawn indiscriminately from the Three Squadrons, each of them was a particular friend either of Woggy, or myself, or of both.

I waited rather anxiously to see whether he would be able to put over this most unusual proposition of his. Woggy had a heart of gold and everybody liked him, but I gathered that this was his first incursion into what he was pleased to call "high finance," and—well, people are liable to turn suddenly very frosty when money comes into the picture. So I waited with some trepidation.

**N**OW Woggy's plump form was pushing its way to the head of the table.

"Spit it out, Woggy! What's the idea—a peace plan, or an armistice for Christmas?"

"It's like this, my dears," Woggy began in a voice rather more serious than usual. "You all know about this Macaroni Cup——"

Several faces turned to each other in mock astonishment. "No! Do tell us about it, Woggy!"

"Shurrup!" commanded Woggy. "This is serious. You all know about this Macaroni Cup, and you all know about the amazing success Sergeant Haystead has had with his 'foozle-board.' But what you don't know is that Sergeant Haystead is in urgent need of money, a fairly large sum."

"So am I!" called several voices. "The larger the better!"

Woggy ignored this. "Nor do you know," he continued, "about his particular private trouble. The fact is that the Sergeant has a wife who has been suffering for some time from T.B."

Now that it was clear that Woggy was talking of serious matters, a silence fell.

"Three winters in a sanatorium in Switzerland, and she will get all right—so the doctors tell him—otherwise, *fini*. But what is the poor little bloke to do?

Hasn't got a bean beyond his pay. And let me tell you fellows—in case you think that this is an ordinary hard-luck story—that Sergeant Haystead gave up his job to enlist in September, 1914, and has been on active service almost ever since.

"Now I've just said that he hasn't got a bean, but there is one asset that he has got—the fozzle-board. You all know what a modest, reliable, little chap he is. When he says a thing he means it, and he's told me definitely that by means of the fozzle-board he's going to win the £1,000 that goes with the Cup and use it to send his wife to a more suitable climate in the winters."

There was a stir at this.

"But," objected someone, "the thing doesn't work on damp days—gets rusty or something."

"What is a fozzle-board, anyway?"

"I can't tell you that," Woggy confessed. "The Sergeant is keeping it a secret till after the competition—as he has every right to do."

"But what's this meeting *for*, that's what I want to know," someone clamoured impatiently.

"Now I'll come to the point," Woggy said. "But bear in mind that the proposition I am going to put to you is my idea entirely, and that the Sergeant would never have suggested anything like it himself, being, as I said, a modest little bloke."

"Come on, Woggy! Spit it out!"

"The Macaroni prize-money can't possibly be issued till after November 30th, which is the end of the three months. We are now in the middle of September. Well, you all know what the weather is likely to be doing in England—getting cold and foggy in the mornings—the worst possible weather for people suffering from T.B. Now Mrs. H. has got it badly, and it's imperative that she should clear out to a drier climate as soon as possible."

"So what?"

"So I have suggested to Sergeant Haystead that I should float a company on his behalf, to be called 'Fozzle-Boards Ltd.'"

"Float a *company*!" The effect on his hearers was staggering. "Phew!



## THE MACARONI CUP

Woggy's been reading 'The Investor's Chronicle'!"

"Hark at the finance-er!"

"How're you going to work it, Woggy?"

"It's all quite simple, really," Woggy explained. "I want to raise an immediate capital of £200—which will be enough to enable Mrs. H. to get out to a drier climate at once and last her for six or eight months. By buying shares in the company you blokes supply that capital."

"Eh?"

"Shares are obtainable from me or Trevelyan at 100 francs each, that's £4,\* and are redeemable at the end of the three months at 105."

"That all?"

"It's equivalent to 20 per cent. per annum," Woggy pointed out. "If you want any more you'd better start a company on your own." He addressed the others. "Some of us, Trevelyan and myself, are not taking any interest anyway. But if you blokes feel like a bet—which is all this amounts to—there's no earthly reason why you shouldn't take your winnings. I'm sure the Sergeant would prefer that. Only one thing more that I've got to say: the death of either contracting party ends the responsibility of both—that's obvious. Now then, those who want to buy Fozzle-Board shares put up their paws. Good!"

Woggy fished out a note-book and pencil, and surveyed the forest of hands with satisfaction. "Good blokes! I thought I could rely on you. One at a time, please, and make the cheques out to me."

"Can we sell our shares if we get hard up, Woggy?"

"Course you can, ass! You might get more than you paid for them. 'Pends on what the Sergeant's score is at the moment—compared with the others."

"Now don't forget to spread the news," he admonished the investors, as they passed out. "Publicity is what we want."

Before dinner that night the whole share capital of £200 had been subscribed.

Twenty-nine officers of the Three Squadrons were taking a sporting chance on the Fozzle-Board.

Three days later Thirlmere returned from the dawn patrol with another victory to his credit. In the afternoon he reported yet another. Both were confirmed by photographs.

The Sergeant finished the day empty-handed. There had been a drizzle of fine rain.

That night Fozzle-Board shares changed hands at 98.

UP early next morning, doing a lonely patrol, an incident occurred that showed to what extent the Macaroni Cup had captured the popular imagination.

I was up at twenty-two thousand feet. By the simple expedient of carrying only a single Vickers and not mounting, in addition, a Lewis gun on the top plane, as was usual with S.E.5's, our squadron had a higher ceiling than most squadrons similarly equipped. Height is a great factor in single-seater fighting, and we were proud of our ceiling.

Up at that height I feared nothing from above, and was keeping my eyes skinned for signs of aerial activity below, when suddenly I spotted a British machine some three thousand feet beneath me crossing the Line towards Hunland. It was of a type quite new to me.

I dived my S.E. to approach nearer and examined the novelty with professional interest. The neat lines of it attracted me immensely. While I was wondering where it had come from, the idea occurred to me that this must be the notorious Wedderburn "Wildcat" that the Camel squadron were getting so cocky over. It was due to arrive about this time.

The "Wildcat" was reputed to be the fastest, most manoeuvrable fighting unit the British aircraft firms had so far turned out. It could climb like a rocket, bank round a half-crown piece, and leave the fastest Fokker as though standing—so they said. I didn't know about that, but what I did know was that the Camel squadron was to be issued with the first model. "Not to be flown across the Line until further orders" was the strict

\* The cheques of officers on active service were cashed by the Field Cashier at the rate of 25 frs. to the £.

## AIR STORIES

injunction that accompanied this honour. "H'm!" I thought to myself. "Must be the Camel Major himself, then."

Following the direction of its course, I noted with some alarm a formation of nine German machines approaching the "Wildcat," but not quite head-on; evidently they were not aware of its presence.

But the British machine had evidently spotted *them*; its pilot altered course a fraction and increased his speed. Phew! He was going to stalk them! I pushed forward my throttle-lever and hoped fervently that I should not be required to take part in that unequal combat. The "Wildcat" streaked forward, but still the enemy armada showed no sign of having spotted it.

**N**OW this stalking business may sound incredible to the groundman, especially when undertaken from in front of the quarry, but, actually, there is a considerable "blind" area in front of a pilot, the very considerable area obscured from view by the engine and the top plane. A single Hun by himself will manoeuvre his machine frequently to keep this area under observation, but a large formation is a less flexible unit, and the leader is quite likely, in his pride of strength, to sail sublimely straight ahead. Add to this the fact that machines approaching head-on do so at a combined speed of anything up to three hundred miles per hour,\* and it will be seen that the "sharp look-out" has to be very sharp indeed. In a matter of seconds, what was an almost invisible speck in the distance becomes the cowl of an engine flanked by two death-spitting guns.

A whole book could be written about the difficulties of the airman in spotting approaching danger, but let this suffice: on the ground, the hunted one need only consider himself in the centre of a *ring* of potential danger; in the air, he must consider himself in the centre of a *sphere* of potential danger.

I watched the new-type fighter racing towards its formidable quarry.

At a distance of one hundred and fifty

yards, tracer suddenly streaked from its guns. Its pilot fired a short burst, which was all he had time for, and then he was zooming vertically upwards with an agility that took my breath away.

Meanwhile the Hun leader was spinning downwards, perhaps disabled, perhaps dead, it didn't greatly matter; the point was that his formation was visibly rattled.

The British pilot, now behind the formation and facing the opposite direction, flicked over in a tight loop, half-rolled to complete the Immelmann, and was on their tails. Choosing the deputy-leader, he came pelting down again, raking that unfortunate German with a hail of lead from his Vickers.

To escape this stream of death, the Hun pulled back his stick to zoom, and then, with a bullet through his heart or head, he must have slumped against the back of his seat, because his machine suddenly wearied of hanging from its prop., and slid backwards on its tail. Flames, like taut ribbons, streamed back as it fell over into a dive.

That was enough for that stout Englishman; the element of surprise being gone, he continued his dive, flashed through the demoralised formation, and was gone. His onslaught had occupied less than a minute.

At once, half-a-dozen of the enemy whirled round and shot down after him.

I pushed forward the throttle-lever and spurred after them. With the advantage of a steeper angle of dive, I was able to put a burst first into the straggler—who seemed to take no notice whatever—and then into his next-in-front. The latter did a swift Immelmann and finished by locking me in a grimly-fought circle of combat that seemed to last hours.

He was good, that Hun, better by a great deal than I. We fought each other down to the ground, and the only reason why I got away with it was that my opponent touched a tree-branch with his wing-tip and smashed himself to smithereens against a railway embankment. I was lucky.

I turned back to have a look at the poor brute and then, just when I was beginning to climb again, I heard a shrill

\* This figure is based on Great War speeds.

## THE MACARONI CUP



*There was no chance of escape for that glittering prize of a Staff car. It was my meat.*

## AIR STORIES

wail of wires and looked up to see that glittering new-type sweeping down towards me, the pilot waving as though he knew me. Stout fellow ! Having shown a clean pair of heels to the Huns, he had come back to see that I was all right.

But Jove ! what a machine he had ! I watched him shoot upwards again in a show-off corkscrew climb that left me as though my S.E.5 were tail-up on the trestles. "Well," I said to myself, "if that's the kind of 'bus that's going to be issued, we shall be home for Christmas !"

Thoughtfully I flew back to the aerodrome.

### CHAPTER V

#### Rival Financiers

"MR. McFANE is under arrest, sir." That was the first thing I heard when I landed. "He wants to see you very special, sir," the ack-emma told me.

Teddy under arrest ! I threw my Sidcot over the man's arm and went in search of him. I was astonished. Since the Cup business started, Teddy had brought down an Albatros and a Rumpler and greatly fancied his chances. Why the arrest ?

I found him sitting on his camp-bed, a smuggled whisky and soda in his hand, and looking by no means downhearted. It was "open" arrest apparently.

"Can you confirm them ?" he clamoured as soon as I entered.

"Confirm what ?"

"Why, those two Huns, you chump !"

"Those two—— ! You don't mean to say that was you, Teddy, in the 'Wildcat' ?"

"But can you confirm those two Huns ?" he insisted impatiently.

My thoughts were in a whirl. "I can confirm the second," I said at last, "the 'flamer.' The first I didn't see the end of. But why are you under arrest, if \_\_\_\_ ?"

But Teddy wasn't listening. "Then unless the 'Archie' people can confirm it, I'm only a 'three-er,'" he said sadly.

"Confound that Macaroni Cup ! Tell me why you are under arrest."

"For taking the 'Wildcat' across the Line, o' course."

"You go and risk crashing that marvellous new-type in Hunland !" I was tired and cross. "Then it serves you right, Teddy, blowed if it doesn't !"

"Curse it !" growled Teddy, kicking the stove. "I thought I was a 'four-er.'"

"Some of you blokes are going Macaroni mad," I said unsympathetically. "Fancy risking a new type of 'bus over the Line like that ! What's your C.O. doing about it ?"

Teddy aimed another vicious kick at the stove. "Confound and blast it ! And Thirlmere and Haystead are piling 'em up like stink !"

"Still, it was nice of you to come back and see I was all right, Teddy," I said kindly.

"Eh ?"

"—to come back and see if I needed help."

"I went back to make sure I should have confirmation of my Huns, my dear fellow." He stretched himself morosely on his bed. "Hell's bells ! I *did* think I was a 'four-er' !"

I left the disconsolate Teddy and, on my way to the ante-room, passed up the wooden steps immediately behind the tall, well-built figure of Thirlmere. He was looking particularly smartly turned out that morning ; his dark hair was as sleek as though stuck down with sealing-wax, and his field-boots gleamed like a polish advertisement. He was the sort of fellow who would have dined in a Sam Browne belt, if that distinction did not belong so exclusively to the orderly officer of the day.

He was a yard ahead of me. Just as he was passing through the door, I heard a low voice count "One, two three !" and a dozen or more voices began chanting as though at a spelling lesson.

"C-o-p-y c-a-t. COPY CAT !"

I arrived on the scene to find a collection of humorous gentlemen led by Woggy Wane stabbing condemnatory fingers at Thirlmere. Their arms shot backwards and forwards like piston-rods.

"Copy cat ! Copy cat ! COPY CAT !"

## THE MACARONI CUP

Turning as red as a turkey-cock, Thirlmere strode, with what dignity he could muster, towards the bar, followed by shouts of laughter. The rag was considered to have succeeded.

"What's it all about?" I asked Woggy.

"Haven't you heard, my dear? That blighter has pinched our idea and is starting a Macaroni exploitation company all for his own ruddy self. Offering 100 franc shares for sale, redeemable on November 30th at 120. Can you beat it? At 120!"

"It doesn't matter much to us," I pointed out, taking the chair beside him. "Sergeant Haystead has sent his £200 home, and that's all we care about. What's the worry?"

"That's all very well," someone broke in, "but Stringer, whose leave has just come through, has got 400 francs locked up in 'Fozzle-Boards.' Naturally he wants to sell out. What happens? Best offer he can get is 73, which means the loss of 108 francs. I tell you that blighter Thirlmere has wrecked the market for 'Fozzle-Boards'!"

"And those rotten 'Camel' shares of his are standing at 103 already," put in someone else.

"What's the score in Huns?"

"Thirlmere's one up."

Woggy fished in his pocket and produced a cheque-book. "My dears, I don't care a tinker's cuss! Who'll sell me 'Fozzle-Boards' at 73?"

THE next day the dawn broke clear and frosty. The Sergeant brought down a Hun on his early "shoot." But later in the day Thirlmere added two more to his score.

That night "Camels" stood at 110 and "Fozzle-Boards" sank to the unprecedentedly low figure of 69. "Camel" shareholders were jubilant; "Fozzle-Board" investors began to look worried.

"Buy!" Woggy Wane urged me, as we waited to go in to dinner.

"Buy what?"

"'Fozzle-Boards,' of course!"

I looked at him dubiously. "Why?"

"Because in some way, my dear,"

Woggy said in a low voice, "the functioning of this gadget depends on the weather. When it rains, it doesn't work so well—like the crossbows of those foreign Johnnies at Agincourt—or was it Crécy?"

"Well?"

Woggy winked. "We're in for a spell of fine sunny weather—the meteorological bloke told me so—said he was buying himself a straw."

"Woggy, you're a chump!"

A FEW nights later, when I was dining in Amiens, an incident occurred that struck me forcibly at the time and turned out, in the light of after events, to be most significant.

It was rather a hobby of mine to seek out little restaurants in back streets—ones I had not visited before—and the little place I had chosen for dinner that night was one of those establishments that cater exclusively for the *petit rentier* class, those worthy folk who turn over every *sou* before they spend it and know where to go for the best food. I was certain of excellent cooking therefore, and there was no chance of meeting noisy acquaintances from the Three Squadrons.

The interior of the place was dimly lit with heavily-shaded lights, and each table was in a bay by itself, separated from the next by a wooden partition. The place was intended for people who take their food seriously and hate any interference that may distract them from the serious business of stoking the inner man. The partitions ensured that each customer was in a little *gourmet's* world all to himself, to which only the waiter had access.

"Here, at any rate," I said to myself, "I shan't be driven crazy by conversation about that infernal Macaroni Cup." I unfolded my napkin, shifted the bread plate to make room for White's "Natural History of Selborne," and was soon lost to everything except the ways of wild things in the English countryside.

It was while I was enjoying a *château-briand* steak you could cut with a butter-knife and sipping an excellent year of Chambertin, that I became aware of a low-voiced conversation in French going

## AIR STORIES

on quite near me, and realised that the table in the recess next to mine was now occupied.

The voices seemed unusually earnest and secretive, but there was no reason why two French business men should proclaim their commercial intentions from the house-tops, so I went on with my reading.

Until, lighting my pipe some time later, I happened to look up and noticed that perched on the hat-peg that overtopped the partition separating me from the next table was an R.F.C. cap. "Hello!" I said to myself. "Who's this who speaks French like a native and comes to a place like this to hobnob?"

My interest aroused, I took my stick in my hand and, reaching up, gently unhooked the cap from the peg. Then I let the stick slide through my fingers and the other fellow's headgear was in my hands. Curiously I read the name, and then just as silently raised the cap to its peg again.

Now why the deuce was a haughty sort of fellow like Thirlmere talking so earnestly with a Frenchman? And what sort of person was he, this Frenchman? I felt justified in acting as a Nosey Parker, because only a few days before Thirlmere had declared in my hearing that he knew no French whatever.

Slipping off my shoes (luckily I was wearing slacks), I stood on the opposite bench and inch by inch raised my head above the partition.

The first thing that met my eyes, of course, was the top of the further partition, the one that separated Thirlmere's table from the next beyond. But that was not all. Resting on the top of that partition were two sets of finger-nails and between them was the forehead and the sandy hair of some other person. As I slowly raised my own head, he was slowly lowering his. All I saw, before they disappeared, was just the forehead and the hair.

This was a bit of a shock. Gently I let myself down to the floor and sat down to think. So somebody else was spying on Thirlmere!

My intense curiosity was now not so much to see the Frenchman talking to

Thirlmere in the next bay, as to know the identity of my fellow "spy" in the bay beyond. Who could it be? Another Frenchman? Not with that hair. An officer of the Three Squadrons, perhaps. I resolved to watch when he left.

Half an hour later I saw the waiter bustling up to the table next but one, the *addition* fluttering in his hand.

"*V'là, monsieur!*"

I heard the chink of money, and a moment later he was holding open the door for the departing diner. "*Bon soir, monsieur!*"

I edged my head round the partition in the best Sexton Blake manner and watched, holding my breath.

A small, stockily-built man emerged from the bay tucking a swagger-cane under his arm. I watched in astonishment as he passed out into the darkness of the street. He was wearing an R.F.C. cap on the side of his head and his short greatcoat bore a sergeant's chevrons on the arm.

You could have knocked me down with a "fever" as the Cockneys say. It was Sergeant Haystead!

## CHAPTER VI

### The Crash that Disappeared

THE first time I saw Thirlmere at work in the air was the next day.

He was a power in the Camel squadron now, was friend Thirlmere, with a tremendous reputation as a killer-man. Already the purple-and-white ribbon of the M.C. decorated his immaculate tunic, and a bar was being spoken of. He had the aggressive spirit, I had to admit that; every possible moment was spent over German territory, and though selfish in team-work, he certainly produced results. Moreover, he was most meticulous in getting his Huns authentically confirmed by independent observers; the R.E.8 folk were getting quite tired of being asked to photograph Thirlmere's "E.A. destroyed."

At this time "Camels" were up to 112 and "Fozzle-Boards" could hardly be got rid of at 60. Only Woggy and I had any large holding of "Fozzle-Boards"

## THE MACARONI CUP

now. If Sergeant Haystead won the Cup we stood to win a packet, because, although we intended to cash in all our shares on November 30th at par only, the ones we had bought from other officers had been obtained at very low figures, and the difference would be sheer profit. But I realised now that there was very little chance of the Sergeant topping Thirlmere's score, and regretted taking Woggy's continual advice to lay out more money in "Fozzle-Boards." Woggy seemed very positive. Sometimes I wondered if he knew the secret of the gadget.

AT the time when I spotted Thirlmere, he was already engaged in a duel with a Pfalz Scout. The two of them were at sixteen thousand feet; I, with only a single Vickers mounted on my S.E., was at twenty thousand.

I had no intention of joining in that fight—too risky. To interfere between one of those Macaroni maniacs and his Hun was now a dangerous business on our part of the front. As likely as not I should have got a warning burst under the tail-skid: "My meat! Keep away, or I'll drill you!" The magnificent Thirlmere would have taken it as a great insult, and I should have felt as though I had snatched the putter from Harry Vardon and holed out for him on the 18th green.

The two of them were whirling round in each other's slipstream in as tight a circle as they could manage. First the Camel then the Pfalz would endeavour to break circle and secure an advantage, only to be out-manceuvred by the other and forced back into the tail-chasing business. I took off my metaphorical hat to Thirlmere; he had met a front-rank fighter in that Pfalz pilot, and was giving him burst for burst.

To add to his difficulties the wind was gradually carrying the combat further and further over Hunland, and if his ammunition ran out it would be an awkward business. That was why I decided to remain on hand.

The thing that amazed me in that terrific struggle was the risks that Thirlmere

took. He seemed utterly reckless; sometimes when they had broken circle he would go streaking right across the enemy's front before zooming up for a dive. True, it was a full deflection shot for the Hun, but it was not a risk that I should have liked to take.

The pair of them were now racing round in a vertical bank, tracer streaking from their guns at the merest glimpse of a tail-skid in a telescopic sight. Suddenly the German flicked over in a complete roll, and sought advantage by circling in the opposite direction. It was an unwise move. At once Thirlmere was on his tail, both Vickers spurting lead. The Pfalz dropped its nose and went hurtling downward, spinning wildly.

Tail up in a power-dive, the Camel shot down in pursuit, swift and purposeful as Death. Thirlmere was holding his fire; he knew too much of the game to waste bullets on a spinning enemy. Some time or other that Pfalz would have to come out of its spin—or crash. Then, and not till then, would be the time to put in the final burst. He held his fire.

I pushed forward my own stick and went down after them to see what the end would be. Thirlmere would need confirmation and the decent thing was to be in a position to give it him.

A few hundred yards from the ground the Pfalz extricated itself from the spin, somehow escaped the hail of lead that Thirlmere put in at that most crucial moment, and went streaking across the countryside with the Camel in pursuit.

One following the other, they shot through a gap between two large elms and I lost sight of them for the moment. But a renewed rattle of machine-gun fire broke out and when, a few moments later, I saw the Camel turning back, I knew that Thirlmere had killed his man. "Well," I said to myself, "there's no doubt that he's a born scrapper, whatever else he may be." I flew over to view the crash. I passed quite close to Thirlmere, but the red helmet was looking down over the opposite side of the cockpit; I don't think he saw me.

Arrived over the field where I thought the crash would be, I saw no crash. In-

## AIR STORIES

stead I saw a sight to make the eyes bulge.

In the centre of that field, calmly taxiing along to the leeward end before turning round for a leisurely take-off into the wind, was a Pfalz Scout—the Pfalz Scout, or I would eat my helmet! It was the one Thirlmere had just shot down! *Must* be!

I turned my head. Thirlmere was almost out of sight.

“Hoy!” I yelled. “That’s not the way to win the war!”

I was so astonished that that Pfalz was already in the air before I got going.

Then I pushed forward the stick and went pelting down to make him a proper write-off. *Tacca-tacca-tacca!* I missed with my first burst and overshot him. I zoomed up to see which way he would dodge, and then got after him. *Tacca-tacca-tacca!* But he gave me a run for my money, that Hun. Careering across the countryside at breakneck speed with only just enough height to clear houses and haystacks, we were like a couple of crazy swallows. As soon as I got him on my sights, he would swerve aside, and I had to begin all over again. It was a tough chase.

I got him in the end, though. It was just as he was approaching a village pond. My burst must have caught him in the back. His wheels got wiped off by the railing round the pond, and the fuselage, with him inside, shot forward into the green, slimy water.

*Whoo-oo-oosh!* The splash seemed to rise to the house-tops.

When I left that Pfalz, it was lying belly upwards in the middle of the pond. No pilot crawled out.

“‘CAMELS’ have jumped to 114!” they told me when I got back to the aerodrome.

“Oh, yes? Why?”

“Thirlmere’s downed another Hun.”

“Has he?” I said grimly. “I’m going to have a talk with Mr. Thirlmere.”

I found him in the Intelligence Hut. The cardinal-red flying helmet was still on his head. I didn’t beat about the bush.

“Look here, Thirlmere! If you have claimed that Pfalz as ‘driven down,’ it’s all right, but——”

He looked round and fixed me with that supercilious stare of his. Did he know that I had been a witness, or didn’t he?

“I’m making no claim for an E.A. driven down,” he said coldly. “I’m claiming one E.A. ‘totally destroyed.’” He picked his combat report out of the tray and slid it across to me.

It was my turn to stare. “But—but, my dear man——!” Hot words of indignation leaped to my lips, but he interrupted me.

“Really, we don’t need to get heated,” he said in that metallic voice of his. “I have the pinpoint of my E.A. totally destroyed, and it will be confirmed by an independent photograph. I see no further need for discussing the matter.”

I laughed then; I couldn’t help it.

“You utter fool!” I exclaimed. “I tell you that that Pfalz took-off again after you had gone! I went down and destroyed him myself, ten miles from your pinpoint!”

He was cool, that fellow. I give him credit for nerve. I was conscious that my face was red with indignation. His own was as calm and inscrutable as a Sphinx’s.

He picked up his map, laid it politely in front of me, and placed his report on top.

“I am claiming to have fought with a Pfalz Scout which I drove down and totally destroyed at K18c 34.92. If I fail to have this confirmed by photograph,” he said, his white teeth bared in a sarcastic smile, “then you may run along to the Wing-Commander and tell him all about it. But, meanwhile, you will not insult me by doubting my word.”

“But I’m telling you that Hun took-off again!” I almost yelled it at him, I was so exasperated. “I shot it down myself—in a pond. Here’s the pinpoint, K17a 61.45!” I threw my own map with the pencil-note on it across at him.

He didn’t look at it. “Absurd! We’re wasting time. Yours was a different Hun, my dear fellow, in a different field.” He walked out.

I got the worst of that encounter be-



## THE MACARONI CUP

cause I lost my temper. But, nonetheless, I was positive that I was right.

Later, when I heard that he had asked Naylor, an R.E.8 man, to photograph his "crash," I went up to Naylor.

"You're going to photograph that pinpoint of Thirlmere's are you, old Naylor? If so, you'll find there's a very nice field there, with lots of daisies in it, but nothing else."

"Meaning?"

"There *is* no crash at that pinpoint."

Naylor shrugged. "Well, I'll have a good look for it anyway." He winked. "I've got a small nest-egg invested in 'Camels' I may tell you." He fastened his chin-strap and turned to go.

"One minute, old Naylor! Will you also photograph this pinpoint while you are about it. There *is* a crash there, in the pond."

Naylor took the slip I handed him, growling. "Some of you blokes seem to think I'm a seaside snapshot man."

Two hours later he handed me two still-wet photographs.

"You're a disbelieving blighter! Here's your crash, and here's his. What do you say to that?"

"Wha-a-a-at!" I snatched the second print from his hand, and there, lying upside down across a hedge, was a crashed Pfalz Scout.

"Naylor, old son, you're twisting!" I looked him straight in the eye. "It's a spoof!"

Naylor yawned. "If you think so, better go and see for yourself," he suggested. "And in future you can take your own sticky-backs; I'm fed up with you single-seater folk."

I did precisely what he suggested. At the first opportunity, which was that afternoon, I sought out Thirlmere's pinpoint for myself.

The crash was just as the photograph had shown. I went down so low over it that I could even read the identification number. K1313—it was a number unlucky for me as well as its owner. I felt furious with myself. Thirlmere had been right after all; I had battered on to another Hun from another field.

I banked round and started for home in

no gracious frame of mind. The prospect of having to apologise to a fellow like him made me simply shrivel. Devil! Why had I made such a fool of myself?

I WAS just in the mood for some frightfulness. So that it was with a certain unholy joy that I espied a big Mercedes car speeding up a long white road beneath my right wing-tip.

Pretending not to notice it, I raced past it and looked back. Two resplendent gentlemen in spiked helmets were lounging at their ease in the back, and to judge from the bear-skin rug that covered their knees, they were Generals at least. The two inferior mortals who sat in front, the driver and the orderly, looked like wooden puppets, so stiffly did they sit at attention.

Jove! I was pleased with myself for spotting that car! It isn't every day that you are hedge-hopping in the enemy back areas and happen on such a tit-bit. All my mental agony at having to apologise to Thirlmere dropped from me at once. Two Hun Generals! In spiked helmets! *And* a bear-skin rug! What luck! I looked to my Vickers.

There was no chance of escape for that glittering prize of a Staff car. The road continued straight for another four miles. Hedges on either side would prevent any attempt to leave it. It was my meat.

Understand my excitement. The destinies of nations have been altered by little chance happenings like this, the arrow that pierced King Harold's eye at Hastings, the chill caught by Napoleon on the road to Moscow. I was all keyed up.

When I had passed the car by a couple of miles or so I banked round. Pushing forward the stick, I dipped my nose until I was no more than twenty feet above the ground and went racing back towards it.

The setting sun was behind me. The road was a streaking white blur beneath me. I shifted in my seat and gave a final glance round. I was all set.

I was going to give those German Generals a long burst of twenty or more. The burst I would give them would begin at one hundred and fifty yards and last till my wheels were within a few feet of their

## AIR STORIES

radiator. I was going to dose that Mercedes and its occupants with the juiciest, deadliest burst in the history of machine-guns. I did nothing of the kind.

And the perfectly good reason was that just as I applied my eye to the telescopic sight, the sun's rays were caught and held by the windscreen of the approaching car.

It is wonderful what a splash of light the sun can make on a bit of glass if it catches it at the right angle. You have seen it for yourself, if not on the windscreen of a car, then on a distant window-pane. It is blinding. Well, you can imagine that when your eye is glued to an Aldis sight, a reflection like that is simply paralysing.

That's what I found. The whole tube of the Aldis was filled with a searing white light of transcendent brilliance. I jerked my head away from it and tried "spraying" by watching the direction of my tracer. Useless, of course ; I couldn't see it. That confounded windscreen was the centre of a sun-splash that covered an area about ten times the size of the actual car. I was done.

Cursing my luck, I pulled in the stick, blinking my eyes until they should become serviceable again. It is no joke screaming along a few feet above the hedges when you are partially blind. On the run back I would get that Staff car.

But when I banked round for the run back, it was too late. The car was stopped ; the black bear-skin rug was lying in the road ; and the two Generals, the driver, and the hot-air footman were nowhere to be seen. I hope they got their trousers nice and muddy in the ditch. I contented myself with putting a burst through the bonnet of the car and left.

Nothing much in that, you will say. Why take the trouble to describe how you tried to "strafe" a couple of German Generals if you didn't succeed ?

But there was more in the incident than that.

Strange as it may seem, it was with a feeling of considerable elation that I headed back for the Line. "Well," I said to myself, "I may have made a fool of myself over Thirlmere's Hun, and I may have fozzled my chance of bringing

the war to an end by shooting up German Field Marshals Numbers 1 and 2 ; but at least I have done one thing : *I have guessed the principle of the famous Fozzle-Board!*"

I chuckled when I thought of the various theories that had been invented from time to time about that gadget. No wonder the thing wouldn't function in wet weather ! It couldn't possibly ! No sun !

My mind went back to the three Fokker triplanes, who, one after another, had dived out of the eye of the sun on to Sergeant Haystead, and my heart went out to them. Since attacking that German Staff car I knew exactly what they must have felt like.

**I**T was the neatest affair, that Fozzle-Board, when I came to inspect it on Sergeant Haystead's invitation a few days later.

The theory was delightfully simple : a Hun will, whenever possible, dive with the sun behind him, so that the observer attacked is blinded by its rays. "But why not, instead of being blinded, blind the Hun ?" Sergeant Haystead had said to himself—and had straightway got to work on his sun-reflecting gadget. The Fozzle-Board which he finally evolved served two purposes :

1. It blinded the attacker, so that he fozzled his burst, by reflecting the sun's rays back on himself by means of its mirror.

2. It provided its user's eyes with partial protection against the sun's glare by means of its "window" of dark-stained mica.

Actually, it consisted of a rectangular piece of mirror-glass eighteen inches by twelve inches, backed by a frame of bullet-proof steel fitted with two clamps at the lower edge for fixing on to the barrels of twin Lewises (between ring-sight and fore-sight). Hinges just above the clamps enabled the board to be pushed flat against the gun-barrels when not required. By means of pins, it could be locked firmly in either position.

In a central portion of the board a "window" had been cut. This was covered by dark-stained mica, and by

## THE MACARONI CUP

looking through it the gunner was able to sight his guns and, at the same time, was partially protected from the sun's glare.

In short, the virtue of the Fozzle-Board was that it took away from the attacker who dived out of the sun 100 per cent. of his advantage and handed over, say, 75 per cent. of that advantage to the gunner.\*

"It's simple enough, sir," Sergeant Haystead said to me with his modest little smile. "You look through the window and you can see him better'n he can see you."

I picked up the beautifully made thing, running my fingers along the smooth sides. Simple it was. It had the simplicity of genius.

But I am getting things in their wrong order ; it wasn't till some time later that the Sergeant showed me his Fozzle-Board.

### CHAPTER VII Macaroni-Mad

**B**Y the time I landed after that abortive attack on the German Staff car, all my jubilation at guessing about the Fozzle-Board had vanished, and my mind was filled with one thought only—the humiliating necessity of having to apologise to Thirlmere. (Because, dash it, I certainly had offered him a deadly insult !)

I was leaning against the door of the hangar for support while I extricated my feet from the legs of my Sidcot, when Sergeant Haystead came up to me. The famous Fozzle-Board, which never left him, was under his arm.

"Sergeant," I said, "I've made a fool of myself," and told him all about the crashed Pfalz. At that time, he and I and Woggy was as thick as thieves on all matters financial. The little man was pathetically anxious that no one should lose money through him, and every success of Thirlmere made him glummer. For him, so much depended on the weather. "Fozzle-Boards" at that

time, remember, were down to 60, and he knew that Woggy and I both had large holdings.

He made no answer to my confession, but when we were walking side by side towards the Intelligence Hut he said quietly : "You haven't made a fool of yourself at all, sir—if you'll excuse me."

I turned to look at him in surprise.

He stopped and, after a careful glance round, felt in the breast-pocket of his tunic and produced an envelope.

"Did you happen to notice, sir, the number of that crashed Pfalz you've just been to see ?"

"Yes," I answered, staring, "K 1313. I remember because——"

He drew from the envelope two photographs, taken with an observer's "oblique" \* camera, and representing two crashed German aeroplanes.

"The Photography Sergeant is a bit of a pal of mine, sir. He gave me these. They are Mr. Thirlmere's last two victories, before the one you've just seen."

"Well ?"

"Will you take a look at them through this, sir ?" And he handed me a magnifying glass, also a loan from the Photography Hut.

Squinting one eye, I examined the first photograph, and caught my breath. Quickly I examined the other.

"K 1313 !—K 1313 ! Both of them ! The same—the same as the number of the crashed Pfalz I've just come from !"

The Sergeant nodded without a word, watching my face.

For a moment I stared at him bewildered, my mind racing over possible theories to account for this astonishing discovery.

"What do you make of it, Sergeant ?" I said at last.

"It's the same machine every time, sir, shifted by lorry to different places. He just pretends to shoot 'em down, and they fix up a 'crash' for him. When their pilots see a red helmet, they know they've only got to play at fighting."

"It looks like it," I agreed slowly. I

\* To try out the principle of Sergeant Haystead's Fozzle-Board, choose a sunny day and place an ordinary dressing-table mirror at one end of the lawn. Adjust to the right angle to catch the sun and retire as far as possible. The "sun-splash" will be found quite blinding.

\* A hand-camera of special type taking oblique pictures ; as opposed to the camera fixed in the floor of the cockpit taking only vertical pictures.

## AIR STORIES

was thinking of all the implications. "It means—it means——"

"That he's a Hun, sir," answered the Sergeant promptly. He had had more time to think this over than I.

My mind flashed back to that night in the restaurant in Amiens and, further back still, to the occasion when Thirlmere had first arrived. "Landring" the Sergeant said his name was. Why?

"Look here, Sergeant, you know more about this man Thirlmere than you have let me suppose, don't you? You knew him before he came here?"

Haystead's face took on a troubled look. "Well, sir, it's always worried me, and I've always felt I ought to keep my eye on him. But, really, until now, I've known very little against him. You see, sir, I was chauffeur to him in London from March, 1913, when Miss Wane died, till July, 1914."

"What was he?"

"What they call a 'man-about-town,' sir. All I knew was that he knew a great many German gentlemen, and that when it looked like war he cleared off in the car by himself, leaving me and the other servants without our wages. I thought he'd gone to join the German army, but when I saw him here——"

"Next thing is to get him nailed," I interrupted. "We've got proof enough here of communication with the enemy. Come along! Oh, by the way, has he recognised you?"

"I don't think so, sir; I've grown a moustache since then, and I've always been careful to keep out of his way."

The Wing Commander was away on leave. Tiggy-Wiggy, my own C.O., was in command of the whole aerodrome. I was glad. Tiggy-Wiggy is the finest C.O. a squadron ever had.

He was not in his squadron office, but a moment later the sleek Wedderburn "Wildcat" landed and taxied almost up to the door. Tiggy-Wiggy had been for a trial flight.

He came forward, pulling off his flying-helmet. "You want to see me, Trevelyan?" he asked with that "welcoming" kind of smile of his. "Come in! Come in, Haystead!" He placed a

friendly hand on the Sergeant's shoulder (how many other C.O.'s would do that?): "Is that the famous Fozzle-Board you have there?"

BY the time we came to an end of our indictment of Thirlmere, Tiggy-Wiggy's face was wearing that unhappy look it always took on when any of us did not behave as English gentlemen should. "There will be some explanation—I hope, I hope." He rang a bell and waited, frowning and fidgeting with the photographs.

"My compliments to Mr. Thirlmere," he said to the orderly, "and I should like him to report here at once."

A few minutes later Thirlmere strode in, clicked to attention and saluted. Immaculate as usual, he was certainly a splendid-looking creature as he stood there erect. That wonderful physique, set off by glistening buttons, shining field-boots, and uniform that looked as though he had been poured into it, was a sight for the gods.

"Ah, Thirlmere," began the C.O. "I sent for you——"

He got no further. Thirlmere's eyes had fallen on the photographs. At once he was a man transformed. Galvanised into sudden action, he leapt back, teeth bared. His hand shot to his hip pocket and whipped out an automatic.

"Stand where you are, all of you!"

As he crouched there like a tiger at bay, his head turned sideways to the door. The key was on the inside. Backing, he felt for it with his left hand. Outside the door, not fifty feet away, we could hear the low drone of the "Wildcat" ticking over.

"I'll blow out the brains of the first man to follow me!" he snarled, whipped through the door, and banged it shut. The key clicked in the lock. We were prisoners.

"Quick!" gasped the C.O. "If he takes that 'Wildcat' to Hunland——!" He leaped to a revolver holster that was hanging on a nail. A shattering roar from outside indicated that Thirlmere had started up the Hispano-Suiza.

It took all six shots of the revolver to

## THE MACARONI CUP

shoot away that lock, and even then we had to use our shoulders. By the time we had crashed our way out, the stocky little Sergeant first, the "Wildcat" was already trundling away with bouncing tailskid.

With a turn of speed that amazed me, Haystead raced after it, head down against the terrific slipstream.

We saw his twinkling legs come abreast of the tailskid. Now he was level with the pilot's cockpit. We saw him raise both arms above his head. Something hurtled through the air and crashed through the arc of the whirling propeller. It was the precious Foozle-Board.

With a yell of rage Thirlmere turned, and half rising in the cockpit, levelled the automatic and fired once—twice. Sprawling headlong, the Sergeant dropped.

But he had achieved his purpose. The Hispano was juddering madly because of the splintered prop. Thirlmere might taxi, but taking-off was out of the question. The "Wildcat" was saved.

"All right, sir; it's nothing—shoulder only," Haystead gasped as we knelt beside him. He raised himself up to watch the scurrying progress of the "Wildcat." Now it had reached the centre of the aerodrome, engine thundering all out.

"Look, sir! The Camels!" the Sergeant gasped. "He's going to pinch one!"

One after another, two Camels had just landed, the occupants quite ignorant, of course, of what had happened. We watched Thirlmere force his labouring aircraft across the path of the one that had stopped, saw him leap from the cockpit, and race over, flourishing his automatic in the pilot's face.

There was no answer to that kind of argument; the pilot dropped to the ground, and the fugitive leaped into his place.

*Br-r-r-rmp! Br-r-r-rmp!* With bursts of engine power the Camel got under way. Tail-high, she went streaking across the aerodrome. For one ghastly moment it looked as though the spy would get back to Hunland.

But we had been reckoning without Teddy McFane. Teddy was the man in the

second Camel, and Teddy had just been witness of that extraordinary piece of piracy.

Teddy's engine thundered as he took-off again. Blue smoke streaked from his exhaust as he nosed upwards. Wires screamed as he dived down with the traitor full in his sights.

*Tacca-tacca-tacca! Tacca-tacca-tacca! Tac!*

It was a sitting shot. Flames belched from the stricken Camel. It flopped downwards on a crunching undercarriage. Then with a deafening roar, its petrol-tank exploded.

There was a momentary silence. Turning, we looked at each other, relaxed. "Thank heavens!" said Tiggy-Wiggy softly.

**H**OW much information Thirlmere would have got away with we never knew; the body was burnt so completely. But the lining of his valise, when we came to examine it, produced enough information about the R.F.C. to fill a manual. His prowess as a "killer" of Huns was, of course, the finest "blind" to his real purpose that any spy could ever have devised—and his prominence in the rivalry for the Macaroni Cup a positive stroke of genius. Teddy had done something really useful for once when he shot down Thirlmere, alias Max Landring.

I took Sergeant Haystead—that little hero—to hospital in the C.O.'s car, saw him comfortable, and wrote to his wife for him.

When I got back, who should bear down on me but the ubiquitous Teddy, seeking enlightenment on a knotty problem.

"I say!" he questioned, in all innocence, "that fellow Thirlmere was a Hun, wasn't he?"

I stared. "Yes, I suppose so. He was spying anyway."

"But he *was* a Hun?—and when I say a Hun, I mean a *Hun*, counting as a Hun."

"Yes, I suppose so," I repeated, bewildered.

"Hurray!" Teddy seized himself by the hand and shook it warmly in congra-

## AIR STORIES

tulation. "I'm a 'four-er' at last, then!"

"Teddy, you're a fool," I told him. "Anyway, the Sergeant's about five up on you, and he'll be out of hospital in a week or so."

"You wait!" said Teddy darkly. "There's two more months to run yet, don't forget!"

I tapped my forehead. "Macaroni-mad."

**I**N these post-war years I sometimes go to Lisbon on business. Whenever I do, I am practically certain to come across sometime or other, in the *Rossio* or the *Avenida da Liberdade*, a large and most luxurious Rolls-Royce, bearing the legend "BRITISH EMBASSY" above its number-plate. Sitting at the wheel, very smart in his chauffeur's uniform, but a little over-topped by the tall footman at his side, is ex-Sergeant Haystead, D.F.M.

I never wave, or even wink, when I see him; the equipage is far too grand for that. But always before leaving Portugal, I drop round to the little house in the *Rua Caescaes* for a bite of supper and a chat about old times over a glass of *vinho tinto*.

Mrs. Haystead finds the climate just suits her, and now the T.B. is no more than a tendency. As for the Sergeant, he just loves being chauffeur to His Excellency. Tiggy-Wiggy got him the job.

The Macaroni Cup? Well, the cheque came through all right, but the cup itself was one of the smallest cups I have ever seen; I fear that the great Giuseppe was not too pleased that it was won by a mere N.C.O.

I never see it lying about anywhere in the little house in the *Rua Caescaes*. But there is a heavy gold bangle that Mrs. Haystead wears, and sometimes I wonder — It was a very small cup.

## NEW AID FOR AIR GUNNERS

**Easier Sighting at High Speed—Famous Warplanes to be on Show—New Monoplanes for the R.A.F.**

**A**n invention which will overcome one of the greatest difficulties of the aerial machine-gunner has recently been adapted for use in the R.A.F. It is primarily intended for use from the rear cockpits of two-seater fighter, day bomber or Army co-operation types, and will enable the observer to train his machine-gun with ease in any direction during sharp turns at high speed.

With the present type of unenclosed machine-gun mounting it is impossible for the gunner to train his gun during a turn even at 100 miles an hour. The centrifugal force and rush of air leaves him helpless to move his gun, far less to aim it swiftly. The new invention, however, enables the gunner, by merely moving himself, to face without effort in any direction, right or left, up or down, with his hands on the triggers and his eyes fixed on his sights.

Details of the contrivance, which has been much sought after by foreign powers, are strictly secret. It is the invention of Mr. Frazer Nash, and is manufactured by the Parnall Aviation Co., of Bristol.

### Five Veterans of the Air War

**FIVE** of the most famous aeroplanes of the Great War, which for years have been standing in a disused airship shed at Cardington, have now been brought to London for permanent exhibition.

One of them is the Short seaplane flown by Lieutenant F. J. Rutland at the Battle of Jutland; another is the Sopwith Camel in which Lieutenant L. S. D. Culley brought down a Zeppelin. The others are representative types of aircraft used in the defence of London during the war.

These machines are the property of the Imperial War Museum, which has now been transferred from South Kensington to its new and permanent home in the remodelled Bethlem Hospital building in the Geraldine Mary Harmsworth Park, Southwark.

Here, for the first time, the Imperial War Museum will have sufficient space for the display of all its exhibits. In addition to aircraft, aircraft models and innumerable air war photographs, these exhibits include 9-inch and 6-inch guns, models of tanks, and a vast assortment of battlefield relics from France, Flanders, Gallipoli, the Holy Land, and wherever else the Allied troops fought during the Great War.

### R.A.F. 'Plane of New Type

**ON** behalf of the Royal Air Force, the Air Ministry has recently placed an order for seventy-five General Purpose monoplanes of revolutionary design. Known as the Vickers Wellesley, this new type incorporates an entirely original form of construction, being built on the "geodetic" system invented by Mr. B. N. Wallis, designer of the Airship R. 100.

The "geodetic" principle is based on the path taken between two points on the curved surface of a cylinder or globe. The frame of a wing or aeroplane fuselage, built on this system, consists of a large number of members strictly placed on this principle and making up a comparatively light web of metal crossing and recrossing, but leaving the wing or body hollow. The advantages of the system are that a saving of nearly 40 per cent. in structure weight can be effected, and the parts thus built are so strong that they retain their essential qualities even when parts have been damaged, as they might be, by gunfire.

In the case of the Wellesley, the system also permits the use of a wing of 73 ft. 6 in. span, yet very narrow—an aerodynamic feature of great efficiency. The machine, details of whose performance may not yet be divulged, is a low-wing monoplane with an 850 h.p. Bristol Pegasus engine and a retractable undercarriage.

# AT FIFTY FEET

Captain George Lexham, ex-R.F.C. and Peace-time Proprietor of the Lexham Flying School, sighed for the War Days of his Adventurous Youth—and then Found Himself Engaged in the Strangest Duel Ever Fought Between Two Light Aeroplanes above a Peaceful English Countryside

By BUCKLEY ROBERTS

**L**EXHAM stared gloomily from his office window out over the aerodrome. The spring day was sunny, with enough sting in the breeze to stimulate the tardiest liver. Business was good; the Lexham School of Flying thrived upon a satisfied clientele; the private affairs of its proprietor and founder held no threat.

And yet Lexham was vaguely de-

pressed, conscious of an undertone, irritating and disturbing.

"What the devil's the matter with me?" he asked himself, testily.

Was it, he wondered, the monotony of things? Despite his irritation a faint smile touched his lips at the thought. If anybody had told him ten—fifteen years ago, that flying could become monotonous!

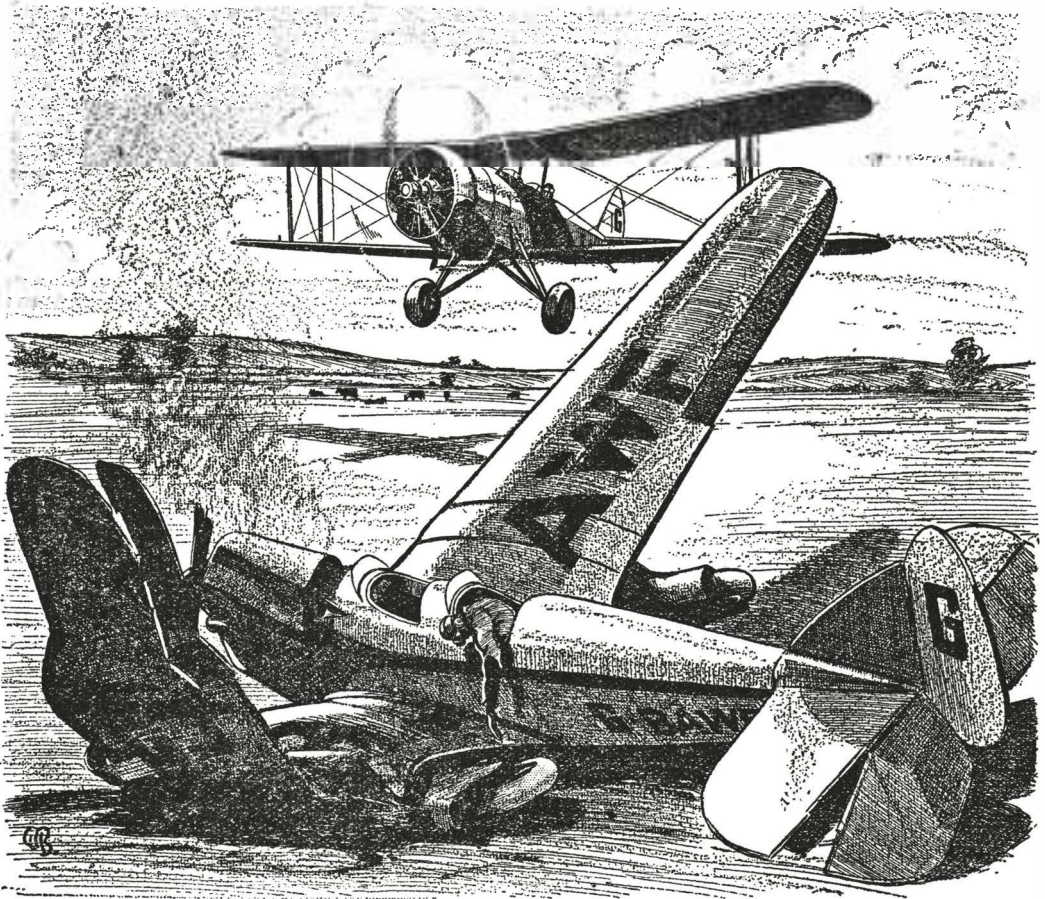

*As though it had been plucked from the sky, the machine crashed into the ground with a rending smash.*

## AIR STORIES

Of course, things were different then. When George Lexham had been Captain George Rodney Lexham, R.F.C., airmen seldom lived long enough to complain of monotony. They learned their flying in a hard school from weary, leather-faced instructors whose job was to transform eager schoolboys into wise, deadly fighting automata in as short a time as possible. One either flew or—well, one could go sick, get out, or crash. Lots crashed. The survivors flew.

Lexham's rapid progress through ground school, dual, solo, gunnery, combat, advanced combat, commission—France, had seemed all too long to him, then. But life was so rapid. Men lived and died between smokes in those terrible days.

He thought of it all now ; the early 'planes : Longhorn, Shorthorn, Avro, Bristol, Camel, Pup (the fearful Pup which would rather spin than fly !), and laughed shortly.

That was flying ! When you were in one of those 'planes you didn't need a war to liven you up. Splendidly planned 'buses, most of 'em ; did wonderful things on paper and bench, and still more wonderful things in the air—only not so reassuring ! And, remembering, Lexham sighed. He sighed because he was thirty-eight and a little tired, tired because his adventurous youth lay behind, because the air and its riders were no longer heroes—were now no more glamorous than 'bus drivers.

Not that youth had been all glory. He had learned about death in those days ; that men do not always die so silently and picturesquely as some war films suggest. There were, still, nights when his uneasy sleep was haunted by other pictures—when he saw again a black-crossed Pfalz plunging down the sky, flame and smoke pouring from its tank ; saw an insanely screaming observer, face half shot away, beating hysterically at the fire which, nevertheless, was no more pitiless than his foe.

And he still dreamed of the day when his elder brother was shot down, when he had gone out to the wreck with the crash wagon ; had stood by in silent horror

while hard-faced men had tried to find enough for burial.

No—not all glory. But one either died—or lived.

"But, damn it," he muttered. "I'm still *flying*. But of course—it's different. It's easy. Australia, America. You could go to sleep in a 'bus nowadays and it'd land by itself !"

A SUDDEN roar of an engine from directly overhead burst in upon his reverie, a roar which was immediately stifled, and followed by the whine and swish of a gliding 'plane. From above the office building, one of Lexham's training Hawks swept obliquely down to a perfect landing. He pushed open the window and called to a man in leather coat who was about to enter the building.

"Hey, Jackson !"

The other stopped and looked up. Joining the school at its inception as a pilot instructor, he had since become Lexham's firmest friend.

"'Morning, George," he said.

"'Morning. Who's in that Hawk, d'you know ?"

"Young Cynthia Lyle—you know, the girl with the fat-wad father. That's her last flip—she finishes to-day."

"Right ; thanks." He closed the window and, going to his desk, drew out a sheaf of pilots' reports from a file and began to study them. Ten minutes later a knock on the door was followed by the appearance of a typist.

"Miss Lyle to see you, sir."

"Very well, bring her in."

Even in his present disgruntled mood Lexham could not help admiring the girl who entered. She looked very business-like in her flying-kit, the keen air had lent a flush to her face and a sparkle to her eyes, so that she brought into the office something of the freshness of the spring morning.

Lexham rose and shook hands.

"Well, Miss Ly'e," he said, "I've just been looking at my pilots' reports. They tell me you're a star pupil."

She laughed lightly and sat down in the chair he placed for her.



## AT FIFTY FEET

"I've done fairly well, I think. I like your pilots."

"I believe," said Lexham dryly, "that the liking is reciprocal."

She laughed outright and became beautiful in the process.

"Oh—strictly in a professional capacity!" she added.

"Quite. And, Miss Lyle, strictly in a professional capacity, I should like to say that you have just accomplished a piece of very bad flying."

Her smile vanished, her eyebrows rose, a touch of hauteur came into her expression. Lexham, watching her, was amused.

("As usual," he thought<sup>e</sup> swiftly. "Only child—lashings of money. Pilots make a fuss of her. Thinks she's Amy Mollison and Amelia Earhart in one.")

"You came down over the building, didn't you?" he asked, aloud.

"Yes"—defensively.

"You cleared it by about ten feet."

"Yes?"

"Yes. I should be failing in my duty as an instructor if I didn't point out how dangerous that sort of thing is. A sudden down draught, an eddy of air from the parapet, and you might have covered the last fifty feet vertically."

"But I didn't."

"No, Miss Lyle, the cemeteries are full of people who have done things wrongly and got away with it—for a time."

She was angry now, less at his criticism than at his manner. Lexham disapproved of the "only child, tons of money, do-as-they-like" type, and could not help showing it.

She rose.

"Mr. Lexham," she said coldly. "I have been under instruction in your school for three months. I have taken my 'A' certificate, have carried passengers, have passed my aerobatic tests, and have put in the best part of the 100 hours' solo flying necessary for my 'B' licence. My instructors have complimented me highly. Everybody who has flown with me is satisfied as to my proficiency. And now, when I have finished, you who sit in an office all day, tell me that I know nothing!"

Lexham, unused to handling women of this sort, gasped at the feminine exaggeration. His business caution, which warned him that "the customer is always right," was swamped by his indignation. Sitting in an office all day! He, who had forgotten more about flying than this damned kid would ever learn! He fought his rapidly mounting temper and rose to his feet.

"I've no doubt that your proficiency is all that you say," he remarked with a touch of bitterness. "But before you go, Miss Lyle, remember this: Any fool can fly at five thousand feet, but it takes a pilot to fly at fifty. As to my office, it may interest you to know that I make a practice of flying every day, when possible. Should you doubt it, I shall be happy to fly with you and demonstrate the truth of my remarks about low flying."

Cynthia Lyle was in a childish fury by now.

"Oh, I know that you fly," she retorted contemptuously. "I've seen you floating sedately round the 'drome in your Cadet like a little boy on a bicycle. And I learned low flying from your instructors, so your lack of faith in them is a poor advertisement for your school. Good-day, Mr. Lexham!"

Positively quivering, she turned abruptly, her leather skirt whisked in the doorway, and she was gone. Lexham stood staring after her, amazed and angry.

"Insulting little blighter!" he said at last. "'Floating sedately'—'boy on a bicycle'—of all the infernal cheek!"

THERE was a step outside, and Jackson's head appeared at the door. He looked puzzled.

"What have you been doing to my soul-mate?" he asked. "She's gone buzzing out of the building like a bee with the toothache."

"Look here," said Lexham. "Can that girl fly?"

"Can she fly?" repeated the other. "George, that girl's a genius with a Hawk. She can do as much with it as she can with me, and what she can do with me is nobody's business!"

## AIR STORIES

"Don't stand there, all head and teeth like a Cheshire cat," said Lexham irritably. "Come in. Now listen, Jack, you're a responsible instructor. Don't you ever tell pupils that it's not good flying to scrape dust off roofs when they're landing?"

"Oh, that was just high spirits! Didn't you ever 'roll' a hangar when you were a kid? Besides, we have to be tactful; she's a bit touchy."

"So I noticed," said Lexham grimly, and related the conversation.

Jackson was tickled. "'Boy on a bike's good," he chuckled. "Still"—more seriously—"you shouldn't have put the family curse on her. She may go around telling people we're no good. Never mind, she's a damn good pilot and we made her; so smooth your furrowed brow and let me drive you into Newbury for lunch."

During lunch, Lexham's irritation was soothed by the cheerful but shrewd nonsense of his companion, and although the vague depression lingered, he began to see the humour of the morning interview. After lunch they drove back to the aerodrome, and, as they strolled over to the hangars, where his Avro Cadet was being prepared for flight, Lexham made his final comments.

"You know, Jack, flying's too easy nowadays. Look at the people we get. Cocky boys and girls who think they're going to fly the Atlantic after three lessons; elderly rakes who want to cut a new dash; cocktail mothers looking for a thrill. How many good pupils do we get—pupils who fly for the sake of flight, for the mastery of a 'bus, for a career? Most of 'em just want a thrill; talk to 'em about aerodynamics or engines and they run a mile. Did you hear that one last week? 'Do tell me, Mr. Lexham,' she said, 'how is it that man doesn't get an electric shock when he turns the propeller thing?' I'd give years of my life to see some of our 'star' pupils handling an old Sopwith Pup!"

"I believe young Cynthia Lyle could handle anything," persisted Jackson. "She may be a bit headstrong, but she's young and full of confidence. Criticism's

hard for people like that. Besides, you're not a model of tact, are you?"

"I don't know what I am," said Lexham, "but let's have this straight—and I'm speaking now as the head of this school. In future, pupils are to be kept off that office roof. When the wind's south, bring them in high and slip across wind—they ought to learn that anyway. And now get on with your job; I'm going for my bicycle ride."

Jackson grinned. "I should," he advised. "It might do your liver good."

THE Avro was all ready now and stood outside the hangar, propeller turning slowly while the engine warmed. It made a fine picture with its aluminium fabric glinting in the sun, and Lexham admired it as he strapped on his helmet. "One thing," he thought, "we've got fine 'buses nowadays. Flying may be easier, but it's more efficient, too."

He climbed into the rear seat, and two mechanics held the 'plane while he revved up the engine. A wave of his hand, the chocks were pulled away from the wheels, and he went skimming out across the field. The machine had been pointed up-wind so that he was able to take straight off, and he climbed slowly—"sedately," Cynthia would have called it—away from the 'drome.

It was ideal flying weather, clear and not dazzlingly bright, except full in the sun; the horizon was sharp and distant, the air was keen without being chilling. Lexham felt his depression lifting. He was in his element here, away from the ground, could forget that the years were piling on him, that his keen youth was past.

This was his never-failing anodyne, the taut response of the stick, the steady roar of the engine, the buoyant rise and fall of the machine. The old alchemists, thought Lexham, had sought for their elixir of youth in the wrong medium; here was the elixir: here was eternal youth: nothing grew old and dried up here—the air was young for ever.

He banked slightly to port, and came round in a wide circle. The 'drome lay

## AT FIFTY FEET

below to his left now. It looked very orderly and minute in the clear light. It was too soon after lunch for any considerable activity; no other machines were up, although two Hawks had been wheeled from the hangar and were being attended by little black figures, as though in some Lilliputian dream.

Lexham felt lazy and was content to sit idly, letting the 'plane fly itself, enjoying the sense of repose and peace. Instead of continuing his circle round the 'drome, as was his habit, he straightened up and headed west towards Newbury, cruising steadily at about two thousand feet. The country looked its best in its new spring green; far behind on the eastern horizon lay the haze that was London; to the south lay Salisbury Plain, melting slowly into blue distance towards the sea, and far to the north could be seen the dim outlines of the Cotswolds—the whole making a perfect setting for a perfect flight.

Lexham found himself remembering other such peaceful flights under different circumstances, when every inch of an innocent blue sky had to be searched constantly by eagle eyes for the surprise attack which never was a surprise. There would be just such an empty sky, just such a sense of peace—perhaps the country would be less beautiful, torn and scarred by two years of savage war, but up here all would be still and calm, not a cloud to hide an enemy, only the V-shaped flight glinting in the morning or evening sun. And then, staring into that sun, with the wisdom that one learned in those days, one would suddenly sight a tiny black speck—two, three, half a dozen! A signal from the leader of the flight, nerves tense, guns ready—the flight would wait for the specks to grow with incredible swiftness into diving enemy 'planes. The old dodge, ever new—hiding in the sun! Automatically Lexham looked up at the sun, narrowing his eyes at the blinding glare.

“But you never caught me, did you, you old blighter?” he said whimsically.

“I was lucky enough——”

The words died on his lips as he stared, stared at the face of the sun through his

goggles. Surely—but no, reminiscence and imagination were playing tricks. A speck on his goggles, perhaps. He brushed his sleeve across the goggles and stared again.

By God, it *was* a speck, a growing speck, a rushing, diving speck!

ALL his old fighting instinct swept back upon him, his hand tightened on the stick, his feet braced on the rudder-bar—and then suddenly he laughed.

“It's England, 1936,” he said. “Some fool trying to scare me.”

Nevertheless he opened the throttle slightly and turned to face the sun, climbing slowly. The speck was undoubtedly a 'plane, diving swiftly. Lexham thought quickly. Suppose—suppose it was some homicidal fool——?

He made his decision rapidly. Better take no chances, he was at a bad disadvantage here. He pushed forward on the stick, opened the throttle and started down in a power dive. The dive became a plunge, the engine bellowed, the whole 'plane quivered, the ground rose towards him like an ascending lift.

Now—he cut the throttle, eased back on the stick, holding off with all his strength. The dive, flattened a little, gradually straightened, the wings vibrated from end to end with the strain. As the nose began to lift, Lexham smacked the throttle wide and drew the stick right back as far as it would go. Up came the nose, the engine roared again and the Cadet flashed upward in a terrific zoom, all the velocity of the dive behind it.

Up, up, up—Lexham thrilled to the surging ascent—this was a zoom that no war-time 'plane could have accomplished without tearing the wings from the fuselage. The speed began to lessen rapidly, the engine to labour. He pushed forward on the stick, shut off, hung for a moment motionless, and then dropped off on one wing, hesitating on the verge of a spin before floating round in a half-circle and taking up even flight again.

Keenly he gazed around and below for the other machine. According to all precedent the attacker should now be beneath because he had been diving while Lexham

## AIR STORIES

was zooming, but with growing amazement Lexham realised that the sky beneath was empty. He twisted in his cockpit, looked back and up.

There, riding his tail, perhaps three hundred yards away, sat the other machine—a dark-blue Miles Hawk, brand new it seemed, sparkling and dancing in the afternoon sun. Lexham caught his breath involuntarily. Had this been war it would probably have been his last breath, for the Hawk was in perfect position to rake him from nose to tail with lead. Sheer instinct rather than fear guided Lexham now. He kicked on left rudder, flung the stick sideways and came sweeping round in a vertical turn.

This was no ordinary pursuer, he realised. Any pilot who could recover from such a dive out of the sun in time to follow a rapid zoom and remain on the tail of his enemy, was a *good* pilot, a trained pilot, a fighter pilot. There was no time for conjecture, however.

The pursuer had followed his lightning manoeuvre with instant decision, and Lexham found himself re-enacting a grim comedy which he had supposed he would never act again after leaving France.

ONE of the first lessons a combat pilot learns is "When he's on your tail—circle." An aeroplane's machine-gun is fired at a fixed angle through the propeller and can only be aimed by pointing the nose of the 'plane at the target. If the target is sweeping round in a rapid circle it cannot be hit because, follow it as quickly as one may, it is always ahead on a curved path, and the gun which fires round corners is not yet invented. The only thing one can do is to join the circle on the tail of the target and wait for the moment when the other pilot can flash round and round no longer.

The only thing that keeps a 'plane in a continuous vertical turn is sheer speed—speed which creates such centrifugal force that the machine cannot slip inward or down any more than water can move in a rapidly revolving pail. The length of time for which any man can stand the strain of such centrifugal force depends on the individual, and when he must come out

of his bank there is a split second when his machine, whatever the manoeuvre may be, will present a momentarily stationary target. Whichever of the combatants is the cooler and cleverer during that split second—lives.

Lexham was in the deadly circle. His war training held him there grimly, waiting. But, for the first time in his life he realised that he was thirty-eight. The exhilaration, the muscular control, the fierce joy of combat were missing. The strain seemed unbearable. In the first few sweeping turns he knew that he was an ace no longer, that he was old, broken, defeated. The air pressure which bowed his head rigidly downward was like an iron weight. His blood pounded, pounded; his breath choked and dried. A black veil seemed to shut down over his eyes—almost unconscious, he snapped the throttle shut and pushed the stick forward and to the right.

The 'plane jerked violently, fluttered, hung—

Lexham sat limply, waiting for that familiar *tat-tat-tat*—for the sound of splintering wood as the bullets smacked home, for the sudden searing agony which was the penalty of defeat. So often had he himself been the stern, relentless victor meting out the penalty. Now—

The nose of the 'plane lifted sluggishly, hung, dropped. The machine plunged downward and went into a spin. The earth swung round his vision in a careening, tilted nightmare. With a superhuman effort he tightened up on the rudder, shut his eyes to lessen the vertigo, fought the increasing spin down to a straight dive and floated up again to an even keel. One thought was dominant in his recovering brain, a thought which gave him back life, renewed his youth, restored his confidence—"He's got no gun!"

He looked back and up again. There sat the Hawk, serenely, calmly, seeming to mock at him in a cool consciousness of supremacy. At any moment during the past two minutes the pilot of the Hawk could have ended the battle. The Avro had been at his mercy.

Lexham stared intently at the flashing

## AT FIFTY FEET

arc of the Hawk's propeller. No, he was sure there was no gun. Then what the hell was the game? Somebody trying to scare him? One of his old buddies playing the fool? Some pupil—a blinding light flashed upon him, nearly causing him to jerk the stick into a dive.

Cynthia Lyle!

He furiously rejected the idea. No chit of a girl with less than 100 hours' solo could outfly him—Captain George Lexham, D.F.C., D.S.C.! At the very thought there welled up in him such a wave of fury and chagrin that he literally gasped for breath.

Well, he'd see. He shut off the engine, putting the nose down just far enough to keep the 'plane gliding comfortably, then, half rising from his seat, he waved to the Hawk, beckoning and pointing down in a wordless request for the other to come down level with him. The Hawk pilot evidently understood, for he started down as though to comply and then, apparently changing his mind, opened full out, dived past Lexham so closely that the Avro bucked in the slip-stream, and soared up again in a glorious loop, finishing in precisely the same position from where he had started—on Lexham's tail!

Lexham swore savagely. It had been impossible to tell, when the Hawk had dived past, whether it contained a man or a woman. The flying-helmet and goggles of the pilot had alone been visible, so that he was no wiser than before.

**T**HEN Lexham went berserk. Never, in his grimmest battles for victory and life over Flanders, had he flown so madly or so brilliantly. Every trick and dodge known to the flying ace Lexham tried. Up and down the sky from eight thousand feet to two thousand, the curveting machines dived and soared. Split turn, chandelle, roll, half-roll, roll off a loop, Immelman. Slipping, sliding, diving, twisting, spinning, until Lexham felt sick and dizzy, tired and old. Still the blue Hawk rode his tail, still the blue wings flashed and turned and followed as though operated by the same control. If anyone below were watching it must

have been a glorious sight, a poem in blue and silver, for, save perhaps the flight of a gull or the darting sweep of a trout, there is no sight more graceful or inspiring than an aerial combat between skilled pilots.

Lexham was beaten. He knew it; he felt it. Youth must be served. But the feeling of despair, of disgrace, was gone. He had been beaten by a genius. Whoever was in that Hawk was no more *driving* it than the brain of a bird drives its flight. That pilot was a part of the Hawk, as much a part as the brain is of the bird, flying it instinctively, not reasoning, not thinking, but riding every gust, controlling every movement with such perfect balance and instinct as an eagle possesses. And Lexham was content to be vanquished by such a pilot. He was too good a pilot himself to fail to recognise such genius and bow to it. Of such stuff were the great ones: Ball, Mannock, Richthofen, Immelman—and a dozen others.

He surrendered, dropping down in a slow spin—itsself admission of defeat, for in actual warfare there is no better target than the 'plane that emerges from a spin.

Then, straightening out, he held both hands aloft in token of surrender, gripping the stick between his knees. He was intensely curious to know whether it was really Cynthia Lyle. He could not believe it—it seemed incredible that a girl with but six months' training should have become such a pilot. Yet, thought Lexham, men had to learn in less than six months in war-time. Given inherent genius, it was not impossible that she should have so progressed.

The occupant of the Hawk saw his signal and waved in reply; then, forsaking his position on Lexham's tail, he swung down until he flew alongside and slightly above the Avro, to the left.

Lexham stared hard at the helmeted head. No, it was impossible to tell. The figure waved an arm and pointed down. Lexham looked down, and suddenly realised that he was lost. The combat had so twisted and turned, drifted and swayed, that miles of country had been covered. They were over open country

## AIR STORIES

now ; far to the right appeared a black smudge that might be a town, but he could not recognise any landmark.

Well, no use landing here, he thought. He knew the compass bearing of the 'drome and its position relative to the sun, for only three-quarters of an hour had elapsed since leaving the field. He shook his head at the Hawk, pointed to the sun, and then at the direction of the 'drome, and began to bank round in that direction.

To his surprise, the Hawk heeled round and, instead of following his lead, came soaring directly overhead, the pilot still stabbing downward with his arm.

"You go to blazes," growled Lexham. "I'm landing on my 'drome and nowhere else."

The Hawk dipped and came lower, still directly overhead.

"Hey, hold off, you fool!" shouted Lexham, and frantically waved the other away.

The blue 'plane never wavered. It dipped lower, lower ; it blotted out the sky from Lexham, its roaring engine mingled with the noise of his own, its wheels threatened the centre section of the Avro. In sheer desperation, Lexham put his nose down and began a turn to get away. The Hawk turned with him and held its position.

Lexham began to lose his temper again. Damn it, why *should* he land here, when the 'drome was only a few miles away ?

He began to twist and turn again, but on an even keel now, for they had not sufficient height to indulge in any more aerobatics. It was useless. The Hawk followed his every movement, and always it rode only a few feet above, pressing him down, forcing him to give way before the threat of collision.

Lexham gave it up, looked about for a suitable landing place. Away to the right was a sweep of grass-land, dotted with grazing cattle. Ahead were fields of young corn, to the left a railway, with low hills beyond. Lexham decided on the pasture. The cattle were mostly herded at one side of the meadow, leaving plenty of room for him to get down. He shut off

his engine, and with a final wave of surrender put his nose down for the field.

THE pursuing 'plane fell off in a half-circle to leave him room, itself intending to land behind him, and to one side.

Then, as he neared the ground, a sudden idea came to Lexham. Why should he land ? Why not get nearly down, thus lulling the other's suspicions, and then smack the throttle wide, go up again and dash for home ? While the Hawk was recovering from its surprise and getting up again he could get a substantial lead and perhaps retain the lead as far as the 'drome.

He cast a rapid glance round : the Hawk was settling, behind and to the left.

Here was the field—down, down, hold her off gently, *now!* Bang went the throttle, the engine bellowed, the nose came up, and away roared Lexham, skimming the hedge like a frightened bird. He held off with just enough height to clear any possible trees and kept the throttle wide, then looked back to see the effect of his manoeuvre.

The pilot of the Hawk had been taken utterly by surprise. Lexham saw the machine, nearly touching the ground, jerk suddenly as the engine cut in abruptly. Up came its nose—too steeply, surely—yes, Good God !

It happened in a second.

The nose of the Hawk lifted sharply to the surprised jerk on the stick, hung for a horrible moment with the propeller clawing at the air in a vain fight for flying speed, and then, sickeningly, the port wing dropped, the whole machine lurched and fell sideways and the wing crumpled into the ground with a rending smash, dragging the nose round abruptly and pitching the Hawk down as though it had been plucked from the sky.

Even as the nose of the Hawk had lifted, Lexham realised what was going to happen, and he came round in as tight a turn as the Avro would make, shut off, glided back over the field and, slipping into the wind, dropped down on to the field near the wreck.

Almost before his machine had stopped,

## AT FIFTY FEET

Lexham was out of it and racing towards the Hawk. If it should catch fire——

He was there. The pilot was struggling feebly in his cockpit. Thank Heaven, he was alive, then ! He turned as Lexham arrived and made a weak gesture.

“The rudder-bar, it’s caught my foot.”

“All right,” said Lexham, “we’ll soon have it out.”

He snapped open the flap of the cockpit, wriggled his head and shoulders past the pilot and wrenched away the broken bar which was jammed across the fuselage, trapping the pilot’s feet. Then he edged back, pulled himself free and looked up. The pilot had removed helmet and goggles.

It was Cynthia Lyle.

**H**E grasped her shoulders and half-helped, half-dragged her from the wreck.

“Are you hurt?” he demanded, anxiously.

She shook her head. “N-no,” she said, doubtfully. “I was so afraid—fire—I——”

She staggered a little, and sat down abruptly on the grass. Lexham stood and looked at her, fighting for words.

“Well,” she queried at last. “Can I fly?”

Lexham seemed to wake up. He took a step forward.

“Shake!” he said, and held out his hand.

She took it with a laugh that had a catch in it, and for a moment they were silent, looking at each other.

“I’m sorry,” she said at last. “Do you know, you’ve given me the finest flying lesson I’ve ever had.”

“I have?” echoed Lexham. “Why, you had me utterly beaten.”

She shook her head. “I simply followed your manoeuvres. And it came off. But you won. You beat me with the last trick.”

“Miss Lyle,” said Lexham slowly, “I am deadly serious when I say that you’re one of the finest pilots I’ve ever met.” (He seemed to have forgotten that he was still holding her hand. So did she.) “I hope you’ll let me fly with you again—often.”

“Oh, but, of course, I’m coming back to the school.”

“What on earth for?”

“To learn to fly.” Then, gravely, “Any fool can fly at five thousand feet, but it takes a pilot to fly at fifty!”

## WAR-TIME SIGNALS OF TWO-SEATER FORMATIONS

*The Official Code issued by R.F.C. Headquarters for use by Formations engaged in Air Combat*

**I**N 1917 R.F.C. H.Q. issued a special code of lamp signals for the use of leaders of two-seater formations. The following code letters were painted on the machine where they were visible to the observer and in reach of the pilot’s hand. When the leader wished to give an order, he placed his finger on the letters required, which the observer then sent to the machines concerned with an Aldis lamp. The order was acknowledged by a lamp, or by wagging the wings if a lamp was not carried.

(1) When working as an escort on raids :

**T T T T** meant Throttle back and hang back.

**E E E E** meant Open throttle and close up.

(2) When working as a single group, from group leader to his two machines :

**N N N N** Bunch, or close up.

**A A A A** Scatter, or open out.

(3) When working as an offensive patrol of two groups, from patrol leader to group leader of rear group :

**SR SR SR** Swing round to the right.

**SQ SQ SQ** Swing round to the left.

**GN GN GN** Groups bunch together.

# AEROPLANES OF *Allied & German Aircraft of*

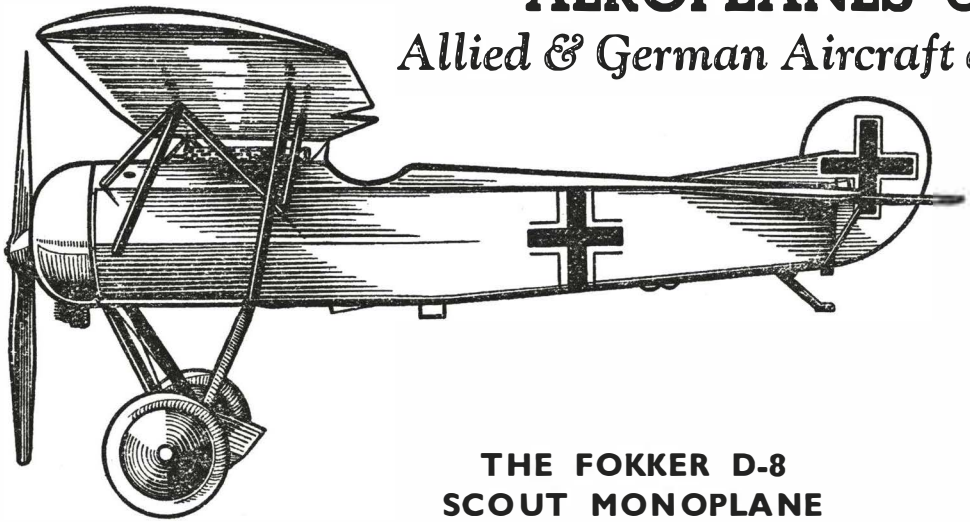

**THE FOKKER D-8  
SCOUT MONOPLANE**

**C**ONTRARY to the assertions of many air-war historians, the Fokker D-8, last of the wartime types of this famous breed, did actually see active service during the last six weeks of the Great War. The first twenty machines produced were scrapped after four had collapsed in mid-air, due, it was believed, to a weakness in the method of wing mounting. This defect was cured by October and a number of re-designed D-8's were allotted to squadrons on the Western Front.

Designed, like the earlier Fokkers, for a steep dive-attack and a quick getaway, the D-8 had a top speed of 124 m.p.h. at eight thousand feet, and was fitted with either a 140-h.p. Oberursel or Goebel engine. Armament consisted of the usual twin Spandaus, and only the intervention of the Armistice prevented this machine from making a name for itself. Chief dimensions were: span, 27 ft. 6 in.; length, 21 ft. 4 in.; height, 9 ft. 4 in.

## **THE DE HAVILLAND 15 DAY BOMBER**

**D**ESIGNED as an improvement on the popular De Havilland 9a, the D.H.15 was a two-seater day bomber biplane, and one of the fastest machines produced during the Great War. The engine was a 500-h.p. Atlantic type, and with this power-plant the D.H.15 was capable of the remarkably high speed of 141 m.p.h. at a height of five thousand feet. At ten thousand feet she could still attain

138 m.p.h. The rate of climb was also exceptionally good, the five thousand feet level being reached in three minutes forty seconds, and ten thousand feet in eight minutes twelve seconds. The greatest height attainable was twenty-four thousand feet. Principal dimensions of the D.H.15 were a span of 45 ft. 8 in., a length of 29 ft. 11 in., and a height of 11 ft. 2 in.

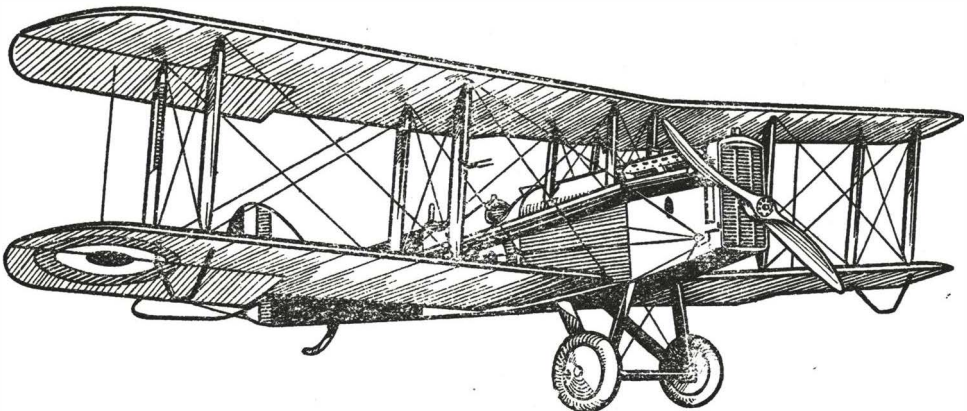



# THE GREAT WAR

1918, which were the Sensations of their Time

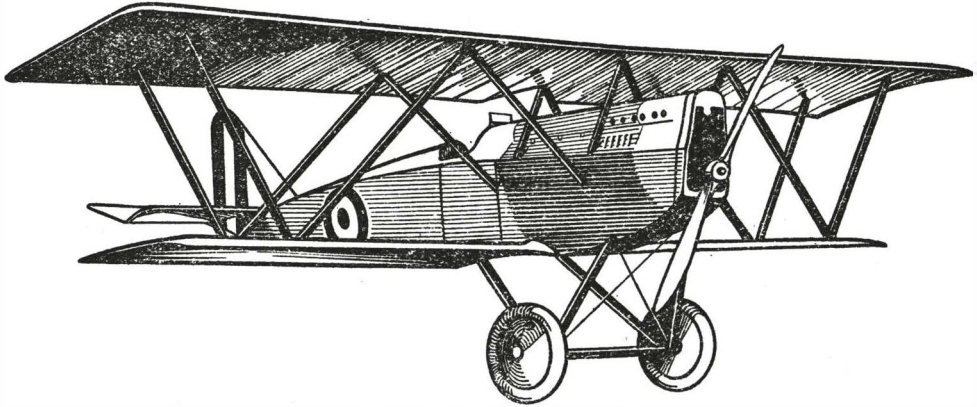

## THE ITALIAN S.V.A. SCOUT

**T**HIS little-known machine was the principal single-seater fighter used by the Italian Air Force in their bitterly-contested duels with the Austrians above the Alpine wastes. A sturdy machine, built to withstand rough usage on badly-surfaced aerodromes, its peculiar strut arrangement was typical of Italian and Austrian design practice

at that time. Powered with a 220-h.p. S.P.A. Ansaldo engine, it could do 139 m.p.h. at five thousand feet, and 131 m.p.h. at ten thousand feet. Fitted with twin floats, this machine was also extensively used by the Italian Navy. The principal dimensions were : span, 29 ft. 10 in. ; length, 22 ft. 11 in. ; height, 11 ft. 6 in.

## THE BRISTOL M.R.I ARMoured BIPLANE

**D**ESIGNED expressly for "trench-strafting," this two-seater biplane had a fuselage made entirely of aluminium and steel, in order to afford protection to the pilot and engine against rifle- and machine-gun fire from the ground. Its value, however, was never tested in active service, as it was produced too late in 1918 to reach the Front. It could be fitted with a 170-h.p. Wolseley Viper or a 200-h.p. Sunbeam Arab engine, but with either power-plant was disappointingly slow, its best speed being only 106 m.p.h. at five thousand feet and 98 m.p.h. at ten thousand feet. The landing speed was 47 m.p.h., and with a fully loaded weight of 2,810 lbs., the M.R.I took eight minutes to reach a height of five thousand feet, and twenty minutes to climb to ten thousand feet.

Its comparatively poor performance was, no doubt, due, in part, to the weight of its all-metal fuselage. The M.R.I was 27 ft. in length, 10 ft. 3 in. high, and had a wing span of 42 ft. 2 in. The gap was 5 ft. 11 in., and the chord, or width, of each wing was 6 ft.

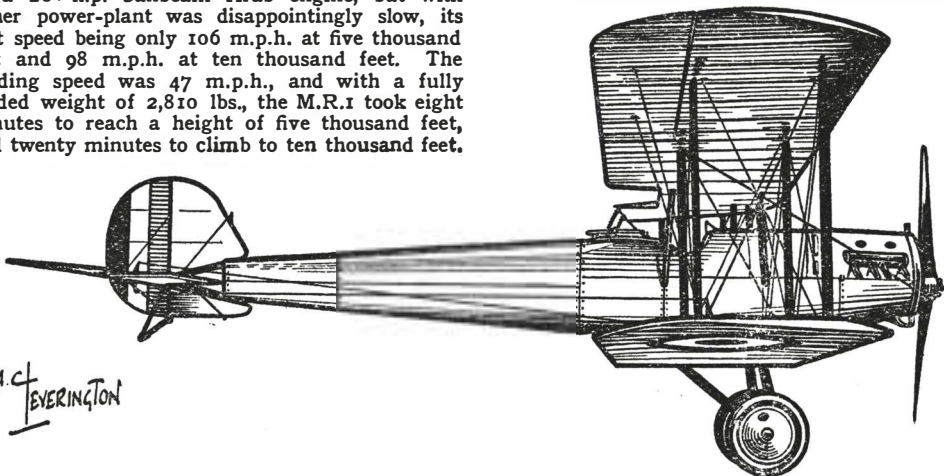

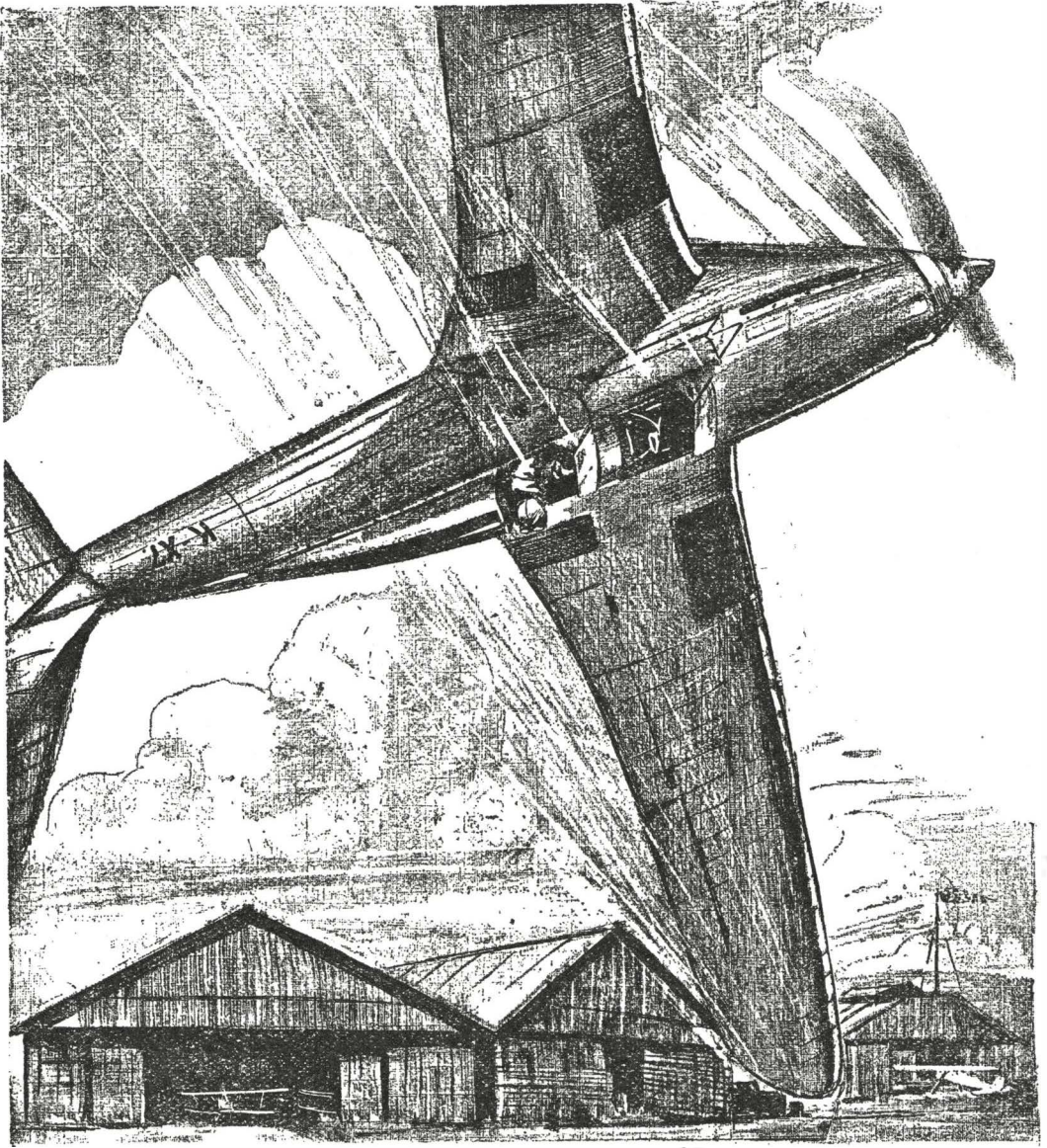

*Right wing down, the Condor hurtled earthwards in a breath-taking sideslip . . .*

**The First of a Great New Series of Modern Mystery Stories.  
By the Author of "Winged Warriors"**

**CHAPTER I**

**The Mysterious Mr. Yen**

**W**HEN Mr. Yen landed at Southampton he was met by three inconspicuous officers from Scotland Yard, who conducted him to a car and drove him with illegal swiftness to a narrow house near Whitehall. In the high-walled garden behind that house a

Cabinet Minister, who looked like a cherub and worked like a galley-slave, conversed with Mr. Yen for a full two hours. The conference being ended, the inconspicuous trio led their protégé to a hotel hard by the British Museum, and then dispersed to strategic positions whence it was possible to observe all who entered or left.

That evening, as he grappled with prob-

# The LOOP OF DEATH

The Frequent Periods of "Special Leave" Enjoyed by Flight Lieut. Kinley, R.A.F., Had a Habit of Coinciding with Times of Unusual Activity at Scotland Yard and the Foreign Office—as in the Affair of the Mysterious Mr. Yen and the Fighter that Wouldn't Stop Looping

By Captain J. E. GURDON, D.F.C.

lems of State, the cherubic Minister vainly endeavoured to forget Mr. Yen. That evening Scotland Yard kept invisible watch and ward over the Bloomsbury hotel. And that evening Tony Carew, recently returned from China, dropped into his favourite club arm-chair, growled cheerfully at the reclining form of Flight Lieutenant Kinley, ordered Scotch, and picked up the late night final.

"I wonder," he mused, some minutes later, "what young Yen's doing in England."

Kinley allowed his six feet of loose-jointed leanness to relax yet more comfortably.

"I wonder," he echoed.

"Doesn't give a hint in the papers, of course?"

"Of course not."

"Merely says he arrived in London this afternoon."

"That's all."

"But there's bound to be something pretty big in the wind. Yen wouldn't have come himself otherwise."

"Oh, I don't know. He may have just popped over to see the sights or what not."

"Blitherer! Have you ever heard of a Chinaman popping anywhere just to see sights?"

"Can't say I have. But then, you see, I've never heard of Mr. Yen, either. Who is he? Friend of yours?"

On various occasions very senior officers of the Royal Air Force had sought to preserve huffy dignity under the bland

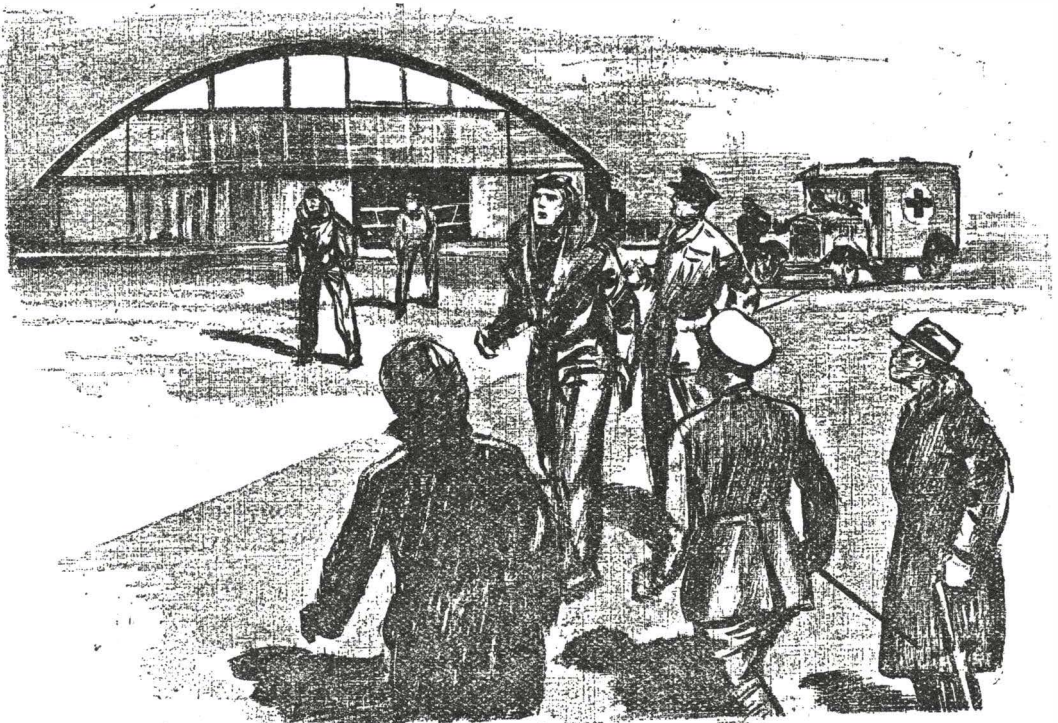

## AIR STORIES

blue stare of innocent inquiry which Alastair Kinley could assume so well. Where those hard-bitten practitioners had failed Tony could not hope for success. Slowly he smiled and laid down the paper.

"Why the devil are you loafing about in London instead of earning your flying pay?" he demanded rudely.

"I'm on leave."

"But—dash it all—you had leave only a month ago."

"True, brother, true. This, however, is special leave."

It was not the first time that Tony had heard of his friend's periodic spells of "special leave," although he alone, outside a certain magic circle, knew what significance attached to that convenient phrase.

"Any use asking what the game is?" he invited curiously.

"None whatever. Haven't the foggiest idea myself as yet. All I know is that I've got to report to the Cherubic Cham in person at ten pip emma prompt, which is"—Kinley glanced at his watch—"in exactly forty minutes' time. Meanwhile, you can buy me a drink and tell me something about—"

"Whew!" interrupted Tony in whistled gratification. "The Cham himself, eh?"

"About your pal Yen," finished Kinley, without change of tone or expression. "He interests me. It's probably nothing but a coincidence, of course, but, as a matter of fact, the cove who rang up this afternoon asked me, in an asinine sort of way, if I liked chop suey and birds' nest soup. Since he's the kind of amiable idiot who's always making jokes nobody else can understand, at the time I naturally thought it was just another one of his celebrated witticisms. Now I'm beginning to wonder. But, anyway, who is Yen?"

There were those who said that Tony Carew knew nothing except how to monopolise the prettiest girl in any given company. They were wrong. Tony also knew China, and knew it with an intimacy and width of understanding attained by few Europeans. Kinley listened with absorbed intensity, his eyebrows drawn

together to form one straight black bar, his lean cheeks hollow as he sucked the steam of a pipe long since extinguished.

"Came the dawn," he murmured at length. "Light breaks, brother. If I understand you aright, Old Man Yen, Generalissimo and father of our distinguished visitor, is the dark horse who's going to win the All China Stakes, and a good many punters among the Western Governments are anxious to get their shirts on at long odds."

"While others," supplemented Tony, "are equally anxious to get at him with a hypodermic syringe."

"I see. Where do we stand in the betting? With shirt or syringe?"

"Shirt every time," answered Tony. "And maybe also laying India by way of a side bet."

"If," said Alastair Kinley, unfolding his long legs and rising, "if there's no connection between the Cherubic Cham, your Chinaman and my prospective chop suey, I'll go straight back to camp and eat my flying-boots."

"Couldn't you do that in any case?" begged Tony.

HE whom his colleagues referred to as their right honourable friend, and whom Flight Lieutenant Kinley irreverently spoke of as the Cherubic Cham, was working in his study when the airman was announced, but immediately left his desk and advanced with outstretched hand. The great little Minister, who thought as little of breaking an untrustworthy servant as a craftsman of scraping a flawed tool, also knew the value of friendship that ignored all differences in age or station.

"The commission that I have for you," he began, as soon as cigars were alight and glowing, "may prove to be no more vital than that of a courier conducting a week-end tour. On the other hand, it may conceivably result in your breaking your neck, or meeting with some equally unpleasant experience. Let us hope that the latter contingency does not arise."

"Let's hope not, sir," agreed Kinley piously, although the grave lines about his mouth twitched as he checked a smile.

## LOOP OF DEATH

He never could get quite used to the Cham's pink chubbiness, or his habit of delivering pontifical platitudes in a plaintively piping voice. Yet that same voice, he knew, had more than once dominated a bitterly hostile House, abashed hecklers and even quelled a mob.

"Have you ever heard of a Chinese gentleman called Yen?" pursued the Minister with apparent inconsequence.

Suppressing a desire to wink, Kinley nodded assent.

"Yes, sir. I heard that he arrived in London to-day."

"Know anything about him?"

"A little, sir."

"Indeed! How much? Tell me all you know."

Secretly hugging himself, Kinley repeated almost word for word what Tony had told him less than an hour before. The Minister listened with a completely impassive face, and his response was cryptic.

"I cannot imagine where you picked up that information," he said, "but I do know that you are either a clairvoyant or a fraud. And I suspect you play poker!"

"*Touché*," breathed Kinley, and waited.

"The fact that you already possess some smattering of the rudiments of the alphabet of the situation," continued the Cham, amiably sardonic, "permits me to approach the point without explanatory preamble. Briefly, then, our visitor has come to Europe on behalf of his father, to place contracts for aircraft, both military and civil. The country which supplies the material will also supply instructors, engineers, *et cetera*, and will therefore be in a pre-eminent position when—as we believe will come to pass—General Yen has succeeded in establishing a powerful, central and constitutional government. Is that clear?"

"Perfectly, sir."

"Very good. Your business, accordingly, will be to take personal charge of General Yen's son, act as his pilot if he wishes to fly, demonstrate machines for him, and so forth. To-morrow he is to visit the Warnford Durrant experimental

station in Essex. You will therefore report at the Foreign Office at ten a.m. Have I made myself plain?"

"Quite plain, sir. But you also mentioned the possibility of broken necks."

"I am coming to that," piped the Cham impatiently. "There are, as you will readily understand, certain—er—influences that would go to almost any length to prevent this country from becoming more strongly and permanently entrenched in the Far East. Information received from agents on the Continent suggests that every attempt will be made to persuade Yen that our machines are not suited to his purpose. If, for example, they were to meet with an accident, or series of accidents, in the course of demonstration, it is unlikely that he would be favourably impressed. You follow me?"

Kinley nodded, knowing that an answer was neither expected nor wanted.

"Moreover, I regret to say that we cannot feel entirely easy regarding the safety of our guest himself. Only this morning an outrageous attempt was made to impersonate him—with what object we can unhappily surmise. Fortunately, Yen was able to expose the impostor and hand him over to the French police at Cherbourg." The Minister paused and sighed. "What is not so fortunate," he went on, "is the fact that the rascal escaped and is still at large. And finally—just to set our teeth on edge, as it were—there are good reasons for believing that this impostor is Max Trübner himself."

IN the silence that followed, Kinley realised, with a shock of suddenness, that the Cham, for all his pink rotundity, was simply a worried little man, old before his time, and wearied by ceaseless toil. Nor could the airman wonder at this slipping of the mask as he pondered the almost legendary reputation of Max Trübner, German-born Chinaman, stormy petrel of the East, the man with half a dozen minor wars to his discredit, killings innumerable, yet the scantiest dossier in the records of any police force.

"Does Yen know that?" he asked quietly.

## AIR STORIES

"Yes, dammit, he does!" exploded the Cham. "And he's scared stiff, poor devil!"

The troubled human moment passed; once more it was an elderly cherub who held out a hand and beamed paternally.

"That's all, Kinley. Good-night. I have implicit trust in you."

"Thank you, sir. Good-night."

An hour later, as Big Ben struck twelve, the Cham briskly informed a dazed secretary that they would be lucky to get through their work before daybreak.

At the same moment Mr. Yen, in his Bloomsbury hotel, listened to the soft footfall of the guard outside his room, looked down from his window at two shadows lurking in the street, and yet, despite this evidence of protection and sleepless vigilance, continued to pace the worn carpet, his ivory face wet and glistening, his fingers locked behind his back like a knot of rigid snakes.

But before the last boom died away Flight Lieutenant Kinley had pulled the sheets up to his ears, grunted contentedly and fallen into dreamless slumber.

## CHAPTER II

### A Test Pilot Bails Out

**A**LTHOUGH officially listed as a civilian flying-ground, the property of the Warnford Durrant Aircraft Manufacturing Company, no Service station received more jealous supervision than Hylton in Essex.

Barbed wire enclosed its boundaries, watchers scrutinised every strange machine in the skies, every car, van or lorry that presumed to approach its entrances, every pedestrian who chanced to linger within sight of the busy hangars.

To be appointed to the staff proclaimed a man's integrity as far above suspicion as his technical proficiency must be beyond all common standards. Even to obtain an entry pass required a character able to emerge unblinking from inquiries as searching as they were discreet. All because Professor Warnford Durrant—of the coppery beard, the tempered steel

brain and the voice like a rusty saw—could build aircraft that did their job just a shade better than those of any other designer in the world.

Such thoughts brought a comfortable sense of security to Flight Lieutenant Kinley at noon next day, as he stood by the side of Rackham, the company's chief test-pilot, and watched the Professor and Mr. Yen circling round a silver two-seater whose engine throbbed and bubbled bassly, the professor's arms demonstrating like a semaphore, the Chinaman's hands clasping a pair of neat grey gloves behind his neat grey back.

The Cherubic Cham, mused Kinley, must have been losing his grip if he seriously imagined that anyone, even Max Trübner, could bring off a spot of dirty work at these cross-roads.

"Decent sort of bloke, your Chinese friend," observed Rackham, chuckling softly as Mr. Yen, with a novice's diffident awkwardness, obeyed Warnford Durrant's voluble instructions on how to climb into the machine's forward cockpit.

Kinley's response was sincere, for he felt friendly and protective towards his nervous charge.

"Thoroughly sound little scout," he agreed, "but he doesn't know a blamed thing about aeroplanes. However, that's our job, not his. Now then, brother, it's time for you to go up and do your stuff. Chu Chin Chow has finished his preliminary look-see and is descending, with considerable difficulty, to terra firma. . . . If he puts his clumsy hoof through that wing, the Professor will infallibly brain him. . . . And if he falls backwards over that leading edge, he'll be decapitated by the prop. Dangerous things, aeroplanes, particularly on the ground. Did I ever tell you the story about my dear old aunt who——"

"You did," interjected Rackham grimly, adjusting the straps of his parachute harness. "And also the one about—— Yes, Professor, I'm ready to take her up straight away."

With a friendly nod at Mr. Yen, he swung himself agilely into the after cockpit, gave one keen, comprehensive glance at the instruments on the dashboard,

## LOOP OF DEATH

settled his face-mask and goggles, and signalled the mechanics to pull away the chocks from the wheels. Beneath the slow, firm pressure of his fingers the throttle-lever advanced two inches, five hundred horse-power quickened into bellying life, and a hurricane napped the grass as the great machine leaped, skimming, before rocketing skywards like a monstrous pheasant.

"Undoubtedly with knobs on," admired Kinley, preparing to enjoy himself.

So far as he could judge, Rackham was about five thousand feet up when he dipped for the first loop. As though drawing a mathematically-perfect circle on the sky, the two-seater swooped up, over and round. Coming out of the loop, the engine snarled again, and again the silver belly flashed in the sun.

A third loop followed, a fourth, a fifth. And with each completed ring the big machine dropped lower.

Like standing dead men, Kinley and Warnford Durrant stared.

At the tenth loop, when Rackham was a bare thousand feet from the ground, the spell upon them broke.

The designer turned to Tukes, his secretary, who always hovered by his elbow. "Ambulance and fire tender," he barked. Without moving his eyes, Kinley began drawing on leather driving gauntlets. More than once had he had tragic cause to handle blazing wreckage. Abruptly then the watchers ceased all movement, as a thing like a small grey ant detached itself from the 'plane and fell with comically twisting limbs.

"O.K.," breathed Kinley, five seconds later. "'Chute's opened."

Mr. Yen's soft accents intruded on their tenseness.

"Why does he make a parachute flight?" he inquired. "I do not understand."

In his relief at seeing Rackham safely floating earthwards, Warnford Durrant became boyishly boisterous. Even when across the aerodrome there thudded a shuddering crash, and flame-stained smoke spurted up from the ground, he scarcely winced. Condor two-seaters

might be duplicated to his heart's content, but not men like Bill Rackham.

"You do not understand?" he boomed, clapping the Chinaman's shoulder. "Neither do I, my dear sir, neither do I. But you may bet your bottom dollar that I shall understand. Unaccountable mishaps never happen twice to our machines."

"It is the work of my enemies," announced Mr. Yen calmly.

The designer started, his red beard out-thrust aggressively. Before he could respond Kinley spoke.

"He's down. Seems all right."

"So he does, thank God, so he does. . . . Mr. Yen, I am sorry that your first impression should include this unrehearsed finale, but I can assure you that we shall get to the bottom of it. Captain Rackham, of course, will be busy on his report for some time, but another pilot will demonstrate another Condor for you —"

"That'll be my job," put in Kinley, "as soon as I've had a few words with Rackham."

"A very sound suggestion. Tukes, have number seven run up, please, and look after Mr. Yen for a few minutes."

**H**URRYING over the springy turf to where Rackham, the centre of a knot of eager helpers, was gathering together the sprawling parachute, Kinley and Warnford Durrant exchanged jerky, breathless comment.

"Must have let her get away from him!"

"Can't have. She wouldn't go on looping by herself."

"Well, he wasn't flying her. I'll swear to that."

"Then what——?"

"Dammit, how do I know? Most likely Rackham doesn't know himself. Hello there, Bill. . . . You all right?"

The test-pilot's hands and voice were steady, although his eyes were still the haunted eyes of a man who has just out-stared death.

"Fit as a flea," he laughed, "but," nodding towards the flaming wreckage a

## AIR STORIES

quarter of a mile away, "the poor old lady is very much of a corpse!"

"What happened?"

Instead of replying, Rackham took them both by the elbow and began strolling towards the hangars.

"Controls jammed," he answered, as soon as they were out of earshot. "That's to say, the stick did. Of course, I had it lugged right back to pull her over the loop. Everything was normal till then. But when we were coming out of the loop, and I tried to ease the old stick forward again, the blamed thing wouldn't budge more'n an inch. There the brute stuck, wedged tight against my tummy, and with me shoving at it for all I was worth! Pretty rotten sort of thing to happen, you know."

Kinley grunted sympathetically. Behind the casual, almost flippant words he sensed, and understood, and shared the lingering horror of that moment.

"Naturally," continued Rackham, "with the stick jammed back like that she looped again—and thundering well went on looping until I said to myself 'This baby's gettin' dizzy,' and hopped out. You see, Professor," he added apologetically, "I had already tried all I knew, and there didn't seem any sense in simply sitting tight and getting all mussed up, did there?"

Warnford Durrant's squeeze on his arm was sufficient answer.

"That being understood," remarked Rackham, visibly brightening, "I'll just jump into number seven—which I see is already ticking over—and try to give Chu Chin Chow a better run for his money."

"You'll do nothing of the sort," retorted Warnford Durrant. "You'll come along with me and down a double of the best, and then we'll go over that wreckage with a fine comb and find out what happened. Kinley can do his own confounded showing off."

"So if you stick around, brother," beamed Kinley, jabbing Rackham's ribs with a long and bony forefinger, "and watch with close and intelligent attention, you'll very likely pick up a few wrinkles and——"

"Grey hairs!" finished Rackham as insultingly as he could.

### CHAPTER III

#### The Death Loop

WITH the contented sigh of an old flier, Kinley settled down comfortably in his seat, tucked his toes under the straps of the rudder-bar stirrups, closed his fingers round the joy-stick, and churned it in a full circular sweep as though he were stirring a Christmas pudding. Noiselessly, the control cables slid through their well-greased leads and pulleys, while the elevator flapped behind and in the wing-tips the ailerons dutifully bobbed.

"Nothing sticky about that," he muttered, kicking left and right upon the rudder-bar. Like the tail of a fish the rudder wagged with soundless ease. "Nor that. . . . Right-o. All clear. . . . Contact!"

A glimpse he caught of a friendly wave from Mr. Yen before the ground dropped away beneath the wings, and the song of the wires was in his ears.

Contentedly he gazed ahead, past the windscreen of the empty cockpit in front, past the long, gleaming engine cowling that sloped so steeply skywards. Where the sun caught the whirling propeller blades, as he turned, they formed two jagged scimitars of light rotating slowly against the spin.

When the altimeter needle quivered at the three thousand mark, he circled back until he was above the centre of the aerodrome, dipped, then slowly, steadily pulled on the stick.

Horizon vanished, clouds and sky streamed dizzily, distant green fields flashed up to form a ceiling, tumbled away into a gulf behind his head, and the loop was over.

"Easy does it," crooned Kinley, pressing his palm against the stick.

A bare three inches forward it moved, then stopped. The muscles of his arm cracked as he pushed. Irresistibly the cowling reared up and over in a second loop.

It was with a queer sense of expecta-



## LOOP OF DEATH

tions fulfilled that he fought the bewitched control. That he was destined to share Rackham's ordeal had been in his mind since the moment of leaving the ground, although imagination had failed to hint how such coincidence could come about, while both reason and experience declared it to be impossible.

Thanks to this unconscious readiness, and to the advantage of having had time for thought, his reactions were resourceful, whereas Rackham's had inevitably been a blind, instinctive urge to break the spell by sheer brute force.

Coming out of the second loop, he ceased all struggles to push the stick forward, and tried, instead, to shift it sideways to the right.

It moved, a cramped and painful movement, because of the narrow space between his thighs, but enough for the ailerons to do their work. The right wing sank.

Kinley's triumphant laugh was torn by a sob of relief. His left foot shot out, pressing the rudder-bar hard askew upon its pivot.

Nose upward to begin another loop, the Condor baulked, held by full ailerons and rudder, then, right wing down, hurtled earthwards in a breath-taking sideslip.

He watched the ground rush up, buildings swelling as though being inflated, aerodrome boundaries flying apart. Tiny figures jumped into view, running furiously—grazing the right wing-tip were blurred hummocks of grass—now stick across to bite into his right thigh, and full right rudder—the wing touched earth and buckled—

Scrambling out of the wreckage he thoughtfully wiped blood from his face before diving head-first into the ruins of the forward cockpit.

His legs were still waving in the air when Warnford Durrant, Rackham and Mr. Yen drew him clear with agitated tenderness. Instead of thanking them, he took the Chinaman gently by the arm.

"You were right," he said, "in thinking your enemies have been busy, and I'm afraid there may be danger to yourself. I am therefore going to ask these friends of mine to stay with you, and not

let you out of their sight for a single moment until I return."

"Return?" rasped Warnford Durrant. "Where are you going? You can't go until——"

"I've got to get to London," snapped Kinley in tones that allowed no further argument.

"What," demanded Rackham, "is that thing you're stuffing in your pocket?"

"Handkerchief."

Catching a cold blue eye, Rackham forebore to point out that handkerchiefs are never made of green canvas webbing.

IN his rare hours of leisure, the Chamleither played an execrable game of golf or wallowed in detective fiction. Eyeing the exhibits which Kinley had placed upon his table, listening to the airman's precise and unemotional report, his mind ranged over scores of gluttonously devoured thrillers, and he told himself most un-Ministerially that this was the goods.

"'The Death Loop,'" he murmured half aloud. "If I were writing that story I should indubitably call it 'The Death Loop.'"

Kinley paused politely.

"I beg your pardon, sir?"

Sighing, the Cham returned to reality and picked up from the table a strip of green canvas and a small adjustable spanner to which was attached a black silk thread.

"Now let me see if I have fully grasped the *modus operandi*," he said. "To begin with, both machines were two-seaters, fitted with complete sets of dual controls?"

"That is right, sir."

"In the front cockpit of each of these machines, even when unoccupied, there is a joystick and a rudder-bar which move in unison with the controls operated by the pilot behind."

"Exactly."

"If, therefore, anything happens to lock the controls in the empty front seat, the pilot's controls will be similarly affected."

"That, sir, is just what happened."

"Quite." Reprovingly, the Cham

## AIR STORIES

shook the canvas strip. "This green band," he went on, "is part of the safety-belt which you removed from the front cockpit of your machine. Since that seat was unoccupied, it would normally have been left undone, but some person buckled the belt, thus forming a noose which stretched from side to side across the cockpit. He then attached a length of silk thread to the belt, fastening the other end of the thread to the dashboard in front, probably by means of a drawing pin. In the centre of the thread was suspended this little spanner. The noose of the safety-belt is now being held over and above the joystick. The trap is therefore set. Explain how it was sprung."

"When the pilot pulled back his stick to loop," replied Kinley, "the stick in the empty seat would also move back as far as it could go, and remain like that throughout the whole period of the loop. But in a looping machine—particularly in a fast, heavy type like the Condor—a considerable centrifugal force is set up, and this force tends to drive everything down towards the floor. In a very tight loop, for example, the pilot feels as though he were being pushed clean through his seat.

"This force, tearing at the safety-belt and the dangling spanner, must inevitably either snap the thread or pull the retaining pin out of the dashboard; whereupon, of course, the belt dropped and neatly lassoed the stick. It couldn't do anything else. Since no amount of pressure on the rear controls would break the belt in front, the machine simply went on looping. And I think you will agree, sir, that the fellow who thought that out has a very pretty wit."

**T**HE Cham nodded absently.

"I still don't quite understand," he complained, "how you managed to stop the looping, whereas the test pilot had to use his parachute."

"Well, you see, sir, the belt was only preventing fore and aft movement—checking the elevator, in fact. The stick could still move from side to side, so I was able to use the ailerons to side-slip down and crash more or less respectably.

People rarely get much damaged in a side-slip crash, because the wing takes so much of the shock. But I'd had time to work things out a bit, while Rackham was taken completely by surprise."

"My sympathies," murmured the Cham, "are entirely with Captain Rackham. Also my respects are with the unknown gentleman capable of devising a method of so damaging our air prestige—for we can imagine the effects of publicity—by means of a thread and a pin which could be adjusted in a few seconds, and which, if noticed after the accident, would never even be suspected. Had you been killed this morning, Kinley, it would have meant the end of our diplomatic relations with General Yen. The fact that you were not killed," he added gravely, "fills me with misgivings for the safety of his son, for it is now quite certain that the man Max Trübner is on his track."

"Why is it certain, sir?"

"Because the French police have recaptured the man who impersonated him at Cherbourg—and he is *not* Trübner! That unmitigated blackguard has doubtless been in England for days."

He threw the spanner and belt back on to the table. "There we have proof of his efficiency. Frankly, I very much wish you had not left Yen, even with two such capable escorts. You must return to Essex at once."

The airman frowned, one thin, brown hand rumpling his wiry hair.

"Couldn't we call in the help of the Chinese Legation?" he asked.

"Impossible. There are the strongest diplomatic reasons why Yen should not have to meet any member of the Chinese Legation."

"In that case, sir," said Kinley, "the sooner I get my man into a machine and off the ground, the better. Also, may I have permission to use the services of a friend, a man called Carew! I can vouch for him."

"What do you want him for?"

"To catch Max Trübner."

"And how is he going to do that?"

"By flying to Cherbourg."

The Cham's eyes were twinkling.

## LOOP OF DEATH

"I am more than ever persuaded," he chuckled, "that you are a clairvoyant, a fraud and a poker-player!"

### CHAPTER IV

#### At the Eighty-Eighth

**H**IS eyebrows raised in mild rebuke, Kinley was idly but conscientiously scanning *La Vie Parisienne* when Tony Carew entered the club on his return from Cherbourg.

"Hello!" he greeted, "and how is the genuine, the authentic, the hall-marked Yen Junior?"

"Very peeved with the French authorities for locking him up twice in one day," replied Tony. "Not that anyone can

"Very, although I couldn't do more than identify him. It wasn't until the Cham himself got on the 'phone that they let him go. He's coming over to-morrow, and he's so bucked to be loose that he'd buy the whole blooming Air Force if he could."

Kinley yawned and prepared to rise.

"Most obliging of him, I'm sure. G'night."

"Not so fast," admonished Tony, pushing firmly. "Not until you've said your piece. I have some slight curiosity concerning certain matters. How, for example, did the ingenious Trübner manage to monkey with the machines?"

"Merely asked, with an air of sweet innocence, if he might hop up into the

*Diagram showing how the safety-belt on the empty seat of the front cockpit was made to fall over the joy-stick and send the machine into the Death Loop.*

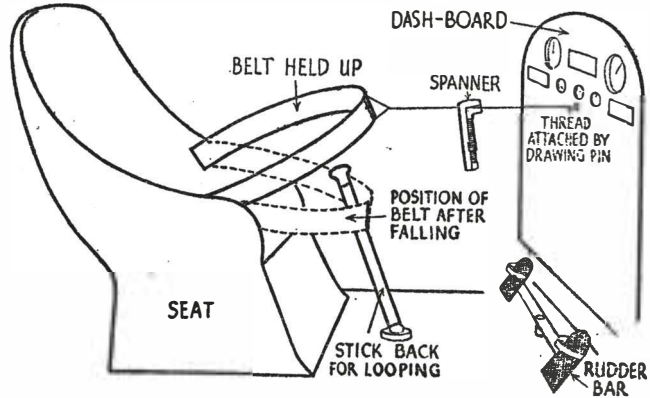

blame 'em. Your playmate Trübner had scrounged every blessed one of his identity papers and, by way of fair exchange, planted on him the highly unsavoury documents of an ex-convict from Indo-China."

Kinley gurgled.

"Max certainly has nerve," he admitted, "although I think his nerve began to wobble from the moment he saw how tenderly Scotland Yard looks after distinguished strangers. He's already complained to the police that he never slept at his hotel because a 'tec was prowling the corridor and a couple of sleuths were in the street. But tell me more about the hapless Yen. Was he duly grateful to you for hailing him forth from the dungeons?"

front cockpit to see the pretty gadgets. Since he was an honoured guest and prospective purchaser, of course we all encouraged such symptoms of intelligent interest. As a matter of fact W. D., Rackham and I stood round and admired him while he was doing his stuff to the first Condor, and later on, when we were all busy discussing the remarkable behaviour of that unfortunate machine, he got busy on the one he knew I was going to fly. It didn't take long, you see. No one on the ground could possibly suspect that he was doing anything so naughty. G'night."

Again Tony pushed.

"But what was the big idea?" he demanded. "Why run all that risk merely to wreck a couple of standard

## AIR STORIES

aeroplanes? He must have known the real Yen would come bounding out of gaol sooner or later and give his game away."

"But not until too late, brother. You forget that Max had all Yen's private papers, including, no doubt, his personal code. You forget that if Rackham and your humble servant had perished in two successive and dramatic accidents there would have been quite considerable public comment. By the time little Yen emerged blinking into daylight, the Grand Old Man in far Cathay would have heard the whole sorry story, embellished by a lurid cable in code, and he would indubitably have placed his esteemed order for aircraft with the Government which Max so ably serves, thereby bringing grief and despair to the Cherubic Cham and giving Great Britain's prestige in the East a powerful sock on the jaw. . . . Please may I go now?"

"You may not! The Cham told me, when I reported to him an hour ago, that you had 'persuaded' the wretched Triibner to make a full confession. Moreover, when he said 'persuaded' the Cham giggled like a schoolgirl. What did he mean? How did you do it?"

**T**HE deep lines round Kinley's mouth widened to the nearest approach to a malicious and unholy grin that Tony had ever seen on that habitually good-natured face.

"By means of a 'Death Loop,' " was the slow reply. "Rather a neat phrase, by the way, 'Death Loop,' don't you think? I'm quite proud of it. . . . Of course, Max himself is the inventor of the stunt, but I fancy I improved upon it. My Death Loop, you see, requires no safety-belts, or spanners and thread, or other adventitious aids. I simply told Max I was going to take him to a safe place—meaning chokey, but he didn't guess that—and got him up in one of W. D.'s Condors. At a snug ten thou. I chucked a loop. Golly, didn't he yell! 'What have you done to the machine?' I howled. 'She won't stop looping!'"

"Why wouldn't she?" interrupted Tony.

"Oh, Patience smile upon me and hold my hand!" Kinley implored in sepulchral tones. "Because, little boy, I wouldn't let her stop looping. On the contrary, I kept on pump-handling that stick like a potman drawing pints for stranded trippers on a wet Bank Holiday. See?"

Tony shook his head.

"Blowed if I do. What was the scheme?"

"The scheme, sweet coz," explained Kinley with effusive politeness, "was to work upon the culprit's guilty conscience, to induce, as it were, a state of mind ripe and ready for contrition. Of course, dear boob, there was not, and could not be, anything wrong with the machine. Even you, I imagine, can hardly suppose that I should let Max get away with it a third time! But try, I beseech you, to put yourself in his shoes. . . . You have tried to murder two men by a certain ingenious method, and have most unexpectedly failed to do so. If you have any gumption at all, you are probably aware that your late-intended victim cherishes suspicions. Then, lo! The said victim begins to treat you to the precise experience which you had designed for him. He accuses you of what you have actually done on two occasions. Even though you know that in this particular instance you are as innocent as a babe, is it not conceivable that, as the treatment continues, your powers of denial weaken until eventually you crack up altogether? Have you never heard of psychology or suggestion, loon?"

"GO on," grunted Tony. "There seems, after all, to have been some method in your madness."

"The operative word should be 'genius,' not 'madness.' Well, to resume. Naturally, Max swore he'd done nothing, but I kept on looping and egging him on to own up until at last—this was about the fiftieth loop—the poor mutt shrieked that he'd do anything if only I'd stop. Nothing doing, of course. I merely informed him that we'd have to loop till Doomsday unless he explained what he'd done to the other Condors. If only he'd

## LOOP OF DEATH

explain, I said, we might have a chance of getting down alive. Suggestion, you perceive. At the eighty-third loop he owned up to dirty work—all this took time, you know, 'cause it isn't easy to chat when you're being slung round like a conker on the end of a string. At the eighty-fifth he outlined the rudiments of his method, and at the eighty-seventh begged to be allowed to die forthwith."

"Instead of which," reflected Tony, "he is going to live a long, long time in a prison cell while we enjoy the proceeds of Old Man Yen's contract." Gradually and gleefully he grinned. "Had to give in at the eighty-seventh loop, eh? Jove, I'll bet he was sick!"

Kinley shuddered.

"At the eighty-eighth," he whispered. "Good night!"

**NEXT MONTH: "The Four Dumb Mouths,"—Another Great Air Mystery Story Featuring Flt.-Lt. Kinley, R.A.F.**

---

# HERE'S THE ANSWER

Readers' Questions are invited and should be addressed to AIR STORIES, 8-11 Southampton Street, London, W.C.2. A stamped, addressed envelope must accompany ALL enquiries.

**ACE OF ACES** (W. Cook, Forfar, Angus). (1) The airman with the greatest number of confirmed victories during the war was Von Richthofen with a total score of 80. René Fonck was widely credited with 125 victories, but French official records give him a total of 75. (2) Captain Roy Brown now lives in Toronto, Canada, but is no longer serving with either the R.A.F. or the R.C.A.F.

**ROTARY AERO ENGINES** (Robert Trotter, Exeter). The question of how petrol was fed to engines such as the Le Rhône, Clerget or Bentley, in which the cylinders rotated, has puzzled many people. The petrol was fed into a stationary, hollow crankshaft whence it entered the crankcase. There the mixture was churned about and then distributed to the cylinders by means of separate branch pipes, similar to those on a radial engine. Normal-type valves were used in the cylinder heads. There is a sectioned working-model of a rotary engine on view in the Science Museum at South Kensington which you might be interested to see when next you visit London.

**LEADER'S STREAMERS** (W. Taylor, New Silkswash, Durham). A flight- or patrol-leader usually carried two streamers and the sub-leader one. There were no set rules as to position or colour, and they were usually attached to interplane struts, though some preferred to wear them on both struts and tail. The original colour was usually white, but they quickly became oil-stained and grey.

**WESTLAND WALLACE** (E. C. Harrison, Nottingham). The Wallace is a general purpose two-seater machine built by the Westland Aircraft Co. of Yeovil, Somerset, and adopted by the R.A.F. Speeds are 158 m.p.h. at 5,000 ft. and 151 m.p.h. at 15,000 ft., and service ceiling is 24,100 ft. Dimensions are: span 46 ft. 5 in., length 34 ft. 2 in., height 11 ft. 6. Armament comprises one forward-firing Vickers, a single or twin Lewis and a bomb load.

**OLD AEROPLANE PARTS** (R. Needham, Ramsey, I.O.M.). Try R. J. Coley Ltd., Queen Elizabeth Road, Kingston-on-Thames, Surrey, for odd parts of obsolete aircraft. Old R.A.F. aircraft and parts are usually sold in quantity by tender, and details of forthcoming sales may be obtained on application to the Secretary, Air Ministry, London, W.C.2.

**WARPLANE PERFORMANCES** (J. F. Riley, Beckenham, Kent). (1) Maximum speeds of the machines listed are: Martinsyde F.4, 145 m.p.h.; B.A.T. Bantam, 138 m.p.h.; R.E.8, 102 m.p.h.; Pfalz D.12, 128½ m.p.h.; Pfalz D.R.1, 123 m.p.h.; Gotha G.3, 73 m.p.h. (2) The Nieuport Nighthawk never saw active service and was still in an experimental stage in November, 1918.

**CAPT. ROY BROWN** (John Hull, Belfast, N.I.). Captain A. R. ("Roy") Brown, D.S.C., was a member of No. 209 Squadron, R.A.F.

**LEARNING TO FLY** (William Middleton Jr., Dent, Yorks). (1) Given fine weather and average ability, you should certainly be able to reach the solo flying stage in the course of a fortnight's instruction, and might well be able to gain your "A" licence at that time. (2) The cost of learning to fly varies according to the time taken and the hourly rate charged for instruction. The lowest rate is usually £2 an hour, and 8 to 10 hours of dual instruction is the usual minimum. (3) Your nearest flying clubs are the Yorkshire Aeroplane Club at Yeadon, Nr Leeds, and the York County Aviation Club at Sherburn-in-Elmet. Good luck to you, and let us know when you get your wings.

**PFALZ TRIPLANE** (F. J. Usgoode, Regent's Park, N.W.1). (1) The Pfalz Triplane D.R.IA was produced in 1917 and had a speed of 103 m.p.h. with a 100 h.p. Oberursel engine. With a 160 h.p. Siemens rotary, speed was increased to 123 m.p.h. at 5,000 feet. (2) The Sopwith Triplane was first produced in May, 1916, and, with a 130 h.p. Clerget, had a speed of 107½ m.p.h. at ten thousand feet.

# AIR BOOKS

The Month's  
Best Books of  
Aviation

## ALL ABOUT AVIATION

*Encyclopædia of Aviation: Compiled and Edited by Squadron Leader C. G. Burge: Pitman & Sons. 15s.*

NEVER before has so much useful information about Aviation been gathered together between the covers of one volume as has been done in this remarkable Encyclopædia. There is no aspect of aviation that does not find some place among its 611 pages, and one can conceive few questions that cannot be answered, clearly and comprehensively, by reference to this book. With contents arranged in alphabetical order, reference is made easy, and whether you require a complete list of all the transatlantic flights ever made, complete with dates, distances and details of machines, engines, and crews concerned, or merely wish to ascertain the principle of a balanced aileron, you have only to turn either to FLI (Flights) or AIL (Ailerons) to find the subject adequately dealt with.

In addition to innumerable definitions of aeronautical terms, more important subjects are treated at length by special articles. The subjects thus covered include Aircraft, Engines, Mechanics of Flight, Practical Flying, Military Aircraft, Commercial Aviation, International Aviation, Ground Organisation, Air Licences, the R.A.F., Air Law—to mention only a few of the general headings.

The scope of the work extends from the earliest beginnings of flying to the most up-to-date technical knowledge of to-day, and the vast amount of useful and historical information that has been compressed into the compass of this work constitutes a veritable triumph of compilation and competent book-producing. Lavishly illustrated with photographs and diagrams, this Encyclopædia is an aviation library in itself and the most useful summary of aeronautical knowledge yet produced.

## A YEAR OF AVIATION

*The Air Annual of the British Empire (1935-36): Pitman & Sons. 21s.*

THE seventh, and latest, edition of this well-known annual presents its customary complete survey of the progress of British Aviation during the past year. Both military and commercial flying, as well as the development of the aircraft industry, are included within the scope of the book, which contains many valuable and informative articles by leading experts on these varied subjects.

Of particular interest, in this year's edition, is the article by Wing Commander E. Howard Williams dealing with the present expansion of the Royal Air Force, the reasons for this expansion and the programme by means of which it is being achieved. The sections devoted to the aircraft and aero-engine industries contain details and illustrations of all the latest British products, while a separate section deals with aircraft accessories and equipment of all kinds. The 800 pages of the book are profusely illustrated by photographs, and its authoritative and up-to-date information should

render it of particular value to those actively concerned with aviation either in this country or abroad.

## SECRET SERVICE THRILLS

*"Thunder in Europe": By John Creasey: Andrew Melrose. 7s. 6d.*

THE action of this fast-moving thriller takes place mostly in England and concerns the activities of one, Marius Krotz, the power behind the throne of a small European state. Krotz, a one-time revolutionary, is closely watched by Secret Service agents of all countries, but it is Gordon Craigie and the men of his Department "Z"—an institution well-known to readers of this author's previous books—who bear the brunt of the struggle and who finally avert an international conflagration by the narrowest of margins.

As in all the best modern thrillers, high-speed air transport plays its part in this fast-moving story, and even if the hero is able to realise he is in a spin only by looking at his controls, and the author rather uncertain as to the connection between an aeroplane's body and its fuselage, these minor defects do not detract from the excitement of a story which has all the qualities of the "thriller" at its fastest and most furious pace.

## CROSS COUNTRY FLYING

*How to Find Your Way in the Air: By G. W. Ferguson: Pitman & Sons. 3s. 6d.*

THIS useful little book, written by a well-known authority on aerial navigation, provides a practical course of instruction in cross-country flying. The essential instruments and equipment are described, and the reader given a sound and not-too-difficultly acquired knowledge of the fundamental principles of air navigation. For those about to take their "A" licences, and also for those who, having learnt to fly, now wish to try their wings farther afield than the limits of their home aerodrome, this book is specially recommended.

## AERIAL ENEMY No. 1

*Sky High: by W. E. Johns: Newnes: 3s. 6d.*

RECENTLY featured in AIR STORIES under the title of "Aerial Enemy No. 1," the adventures of Captain "Steeley" Delaroy have now been published in book form. "Sky High," as the book has been called, contains all three of the long instalments which were printed in this magazine and, at the modest price of 3s. 6d., will be welcomed by the many readers who expressed a wish to add this exciting mystery story to their library of air books. To new readers who have not yet met that modern Raffles of the Air, "Steeley" Delaroy, we can only advise the earliest possible acquaintanceship with a character who is likely to rival even the popularity of the famous "Biggles" in the estimation of Mr. W. E. Johns' admirers.

# A "Circus" Master of the Air

**Pioneer of Formation Fighting Tactics, Oswald Boelke Gained Forty Victories within Two Years and Gave His Name to those Ghost 'Planes of the War that Brought their Dead Pilots Back to Earth**

By  
A. H. PRITCHARD



Oswald Boelke—a sketch from a wartime photograph.

**W**HENEVER one thinks of the German "circuses" or *jagd-staffeln* of the Great War, they are at once associated with the name of von Richthofen, the "Red Knight" of those famous formations that bore his name. But what of the father and founder of this system of air fighting, the man whose patience and skill welded a group of unseasoned pilots into a skilled, destructive formation of fighters—Oswald Boelke, best-loved of all German war pilots? As an "Ace" with forty victories to his credit, he is well known, but the rest of his story is familiar to few.

Born at Giebischenstein, near Halle, on May 19th, 1891, Boelke was, according to his schoolmaster father, to be a teacher—or his fond parent would want to know why. Alas for the paternal hopes and dreams, the young Oswald had other ideas and, voting for an army life, he joined the signal branch at Coblenz as a cadet in 1913. In the meantime, his brother, Wilhelm, had joined the aviation service and in his

letters home was loud in praise of the comforts to be found in this new branch of Germany's martial might. Oswald, working hard at his wireless keys, heard of these letters and decided to try his luck in this aviation game. So determined were his efforts that he succeeded in transferring to the air service early in June, 1914, and after training on the Aviatiks and Taubes, proved to be such an able pilot that he was awarded his certificate on the 29th of July.

## A Baptism of Fire

**N**EXT month, war rumbled across the world, and in September Boelke was assigned as pilot to an observation squadron operating on the Champagne Front. Three days later, he made his first flight over enemy territory, an uneventful ninety minutes' flight that passed unmarred even by ground fire. On October 12th, however, he was sent to obtain information on the movements of French reserves and had to fly through a veritable hail of gun-fire. Every

## AIR STORIES

French gun in the sector opened up and let fly at his Aviatik, but not until his observer signalled that he had the desired information did Boelke turn for home. For his coolness under fire and the valuable information obtained, both he and his observer were awarded the Iron Cross.

For the next few months, Boelke flew daily on routine patrols with little chance of action, then, on May 17th, he was transferred to Douai, where he was introduced to Max Immelmann, already famous as one of the pilots who had bombed Paris. Slower and more methodical than the dashing, reckless Immelmann, Boelke was by far the sounder pilot, and when the first Fokker E-1, complete with its synchronised gun, arrived at the field, he was the man chosen to fly it and report on its performance.

The machine arrived on the 24th of June, and six days later Boelke took the machine into action. He dived on a French Caudron, but a defective cartridge caused the gun to jam beyond hope of a clearance, and he had to draw off. With the gun completely overhauled and new cams fitted, he decided to try his luck again on July 6th. Over Vouziers he encountered a French Morane and shot it down after a whirlwind battle that lasted for nearly twenty minutes. The High Command was delighted with his success, and another Fokker was despatched to Douai aerodrome and assigned to Max Immelmann, while Boelke's machine was tried out by other pilots of the squadron.

For two months Boelke flew the Fokker and his old Albatros two-seater alternately, without breaking into the records. September brought more Fokkers, and Boelke bade farewell to two-seaters for ever and became a scout pilot *par excellence*, scoring his second victory at the expense of a Farman, on the 18th of the month. A few days later, the Kaiser visited Metz on a tour of inspection, and Boelke was one of the ten pilots chosen to afford him aerial protection. Early in the morning of the 27th, a formation of twelve Voisin

bombers attacked the town and bombs fell uncomfortably close to the Imperial headquarters. Boelke took-off alone to intercept them, and after sending one of the raiders down in flames, he had little difficulty in dispersing the rest. By the end of the year he had secured five victories, and both he and Immelmann received silver cups from Thomson, commander of the German Air Service.

On the last day of the old year Boelke was ordered to try his skill on the troublesome British Front, and it was there that fresh honours came to him. On the fifth day of the New Year he shot down a B.E.2c, and followed up with another the next day. His eighth victory came five days later, a few hours before Immelmann also claimed his eighth. That night, telegrams informed both pilots that his Imperial Majesty had been pleased to award them the *Ordre Pour le Merite*, the highest decoration the Fatherland could bestow, and went on to invite them to dine with His Majesty on the 14th. Three hours before he was due to appear before his Emperor, Boelke went up and destroyed a Vickers "Gun Bus," and had to change in record time.

### Boelke Meets Richthofen

**E**ARLY in March, Boelke was again sent to the French Front, this time on the Verdun sector, and on the 13th he scored his tenth victory. Near the infamous Dead Man's Hill, he ran into five Voisin two-seaters returning from a raid in Germany, and, without hesitation, plunged for the rearmost 'plane of the formation, sending it down with one concentrated burst of fire. A week later his score stood at thirteen, and he was given three weeks' leave, returning to the front on April 27th. Once back in harness, he was determined to pass the ominous figure 13, and on the 29th he made an attempt. Over Fort Diaumont, he found a Morane and destroyed it in less than a minute—so much for superstition.

The morning of May 21st brought him his long-promised promotion to the rank of Captain, and he celebrated



## A "CIRCUS" MASTER OF THE AIR

it the same day by destroying his first double—both Nieuport Scouts that crashed near Dead Man's Hill. His score stood at nineteen when he defeated still another Nieuport on June 23rd, but by that time the High Command had decided to remove him from the front. Immelmann had died on the 18th, at a time when the Fatherland could ill afford to lose experienced scout pilots, and they made sure that nothing should happen to Boelke by sending him on a tour of the eastern theatre of war. Whilst on this tour he was given a free hand and authority to demand any likely scout pilot's transfer to his own command. Chief among those chosen by Boelke on this tour was Manfred von Richthofen, destined to become the greatest of them all.

By August 30th, 1916, Boelke had organised the group that was to take its place in history as the famous *Jagd-staffel 2*, and the pilots eagerly awaited their new machines. On September 3rd, the promised machines arrived and drew many a gasp of admiration—sleek Albatros D.1's, with a 160-h.p. Mercedes engine in the nose and two deadly-looking Spandaus atop of the engine. The pilots were delighted with their new 'planes and clamoured for a chance to take them into action, but, wisely enough, Boelke first bade them get better acquainted with their new equipment, especially their guns. Meanwhile, he took his own machine out in the afternoon, and on his first flight in it, blasted a D.H.2 to pieces. For a week he and his black machine waged a one-man offensive, destroying a "Gun Bus" on the 7th, another on the 9th, a D.H.2 and an R.E.8 on the 10th, and finished up with two Sopwith 1½ Strutters on the 16th. The enthusiasm of his men knew no bounds and, inspired by his display, they were ready to stage a few battles on their own account. Accordingly, he took the whole squadron aloft on the morning of the 17th, a date that was to be inscribed in red letters in the aerial history of the Fatherland.

Over Cambria the squadron encoun-



Manfred von Richthofen, who owed his transfer to the Western Front to Boelke's recommendation.

tered six F.E.2d's and two B.E.2c's from No. 11 Squadron, R.F.C., and the entire flight of British machines was put out of action, Boelke destroying an F.E. for his twenty-seventh victory. Before that day was over, nearly every man of *Staffel 2* had secured a victory.

### The Ghost 'Planes of Death

TEN days after this mass slaughter, Boelke attacked two Martinsyde Scouts of No. 27 Squadron, R.F.C. He fired a quick burst at one, then dived and shot down its companion. Turning to attack the first machine again, he had one of the strangest experiences of his career. The British pilot took no notice of Boelke's attack, and continued to fly in an aimless circle. Cautiously, Boelke edged his Albatros closer and was amazed to see that the pilot was stone dead. Shocked at this terrible jest of Old Man Death, Boelke flew home and reported this strange derelict of the sky. Records have since proved that the pilot was a Lieutenant S. Dendrino, of No. 27 Squadron, and the machine made a perfect landing behind the British lines, a post-mortem examination

## AIR STORIES

revealing that the pilot had been dead for over two hours. Before the war ended nearly a dozen reports of similar "ghost 'planes," landing with dead men in the cockpits, were proved, and these strange machines were called "Boelke 'Planes" by the German airmen.

October dawned, and with it came the formation of new fighting *staffels*. Boelke spent the major portion of his time aiding in their formation and advising as to how they could be employed to the best advantage. Tearing himself away from his reports, on the 10th, he left his pen long enough to shoot down a Sopwith Strutter, the first of another string of victories. An F.E.2b went down on the 13th, and two days later, a Nieuport fell in flames. The 16th brought him his fourth double victory when he destroyed a B.E. and F.E.2b over Cambria, to make his total score thirty-five.

### Boelke's Last Fight

**I**N THE mess that night, one of his pilots, Erwin Bohme, remarked: "Only fifteen more, sir, and you will have a half hundred—and no man will ever equal that." Boelke merely smiled and said, "You mean, no man will live long enough in this war to reach such a total." Strange irony, for though many pilots did reach and pass that total, Boelke was never destined to reach his coveted half-century.

The next ten days brought him five more victories, his last two victims being a B.E. and a Nieuport, both destroyed on the 26th.

Two days later he led a formation of twelve machines on an offensive patrol near Poitiers, and, just north of the town he sighted two D.H.2's from No. 24 Squadron. Signalling six of his men to follow him down, Boelke dived to the attack, and the two British pilots, Lieutenants A. E. McKay and A. G. Knight, prepared to sell their lives dearly. Down came the black Albatros, with Boelke at the stick, flanked on either side by one of his pilots. As he zoomed to attack the D.H.'s from beneath, Bohme also turned for the same purpose, just as a vagrant puff of wind caused his machine to skid sharply. Vainly Bohme fought to right his plunging Albatros, but was too late to avoid a catastrophe. The top wing of his machine cut clean through the V-strut of Boelke's 'plane, and one wing of the leader's machine crumpled to send the fuselage plunging to earth like a stone.

Thus died Boelke, a gentleman in the best sense of the word, a kindly, quiet man, who killed out of necessity, but who preferred to bring his victims down unharmed.

Mourned by friend and foe alike, no finer tribute was given any man than that which Boelke received from his enemies. It was a laurel wreath, dropped by parachute, and the inscription read:—

*"To the memory of Captain Boelke, our brave and chivalrous opponent.*

*"From the English Royal Flying Corps."*

### VICTORY LOG OF CAPTAIN BOELKE

7 Nieuport Scouts.  
1 Caudron three-seater.  
2 D.H.2's.  
2 R.E.8's.  
4 Sopwith 1½ Strutters.  
4 F.E.2b's.

1 Martinsyde Scout.

3 Morane two-seaters.  
1 Morane Scout.  
5 Farman two-seaters.  
3 Voisin two-seaters.  
4 B.E.2c's.  
3 Vickers "Gun Buses."

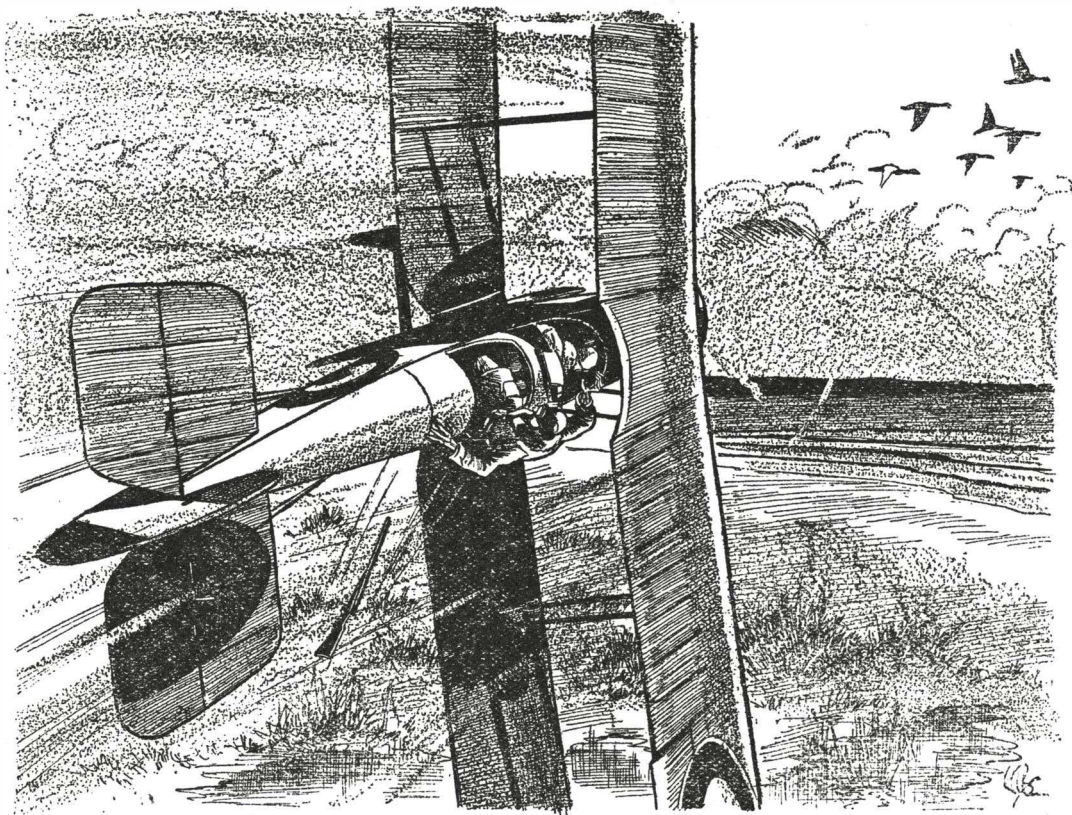

*Forgetting his passenger, Elliot flung the Avro over into a splitair turn.*

## MYSTERY OF THE MARSHES

Wild Duck may Seem Poor Game for a Man Accustomed to the Formidable Warbirds of Flanders, yet Captain Oswald Sparling, R.F.C., lately Returned to Home Establishment, soon Discovered that this Old English Sport could Afford Experiences more Startling than Any He Had Ever Encountered on the Western Front

By MILFORD HYDE

### CHAPTER

#### An Order from Wing

**M**AJOR CORMLEY was in the squadron office, dealing with the usual pile of hot air from the Wing. By a system of sorting the correspondence into three heaps which were handed to the Recording Officer, the Squadron Sergeant-Major, and the orderly-room clerk respectively, he disposed of the majority of the papers in five minutes; there only remained a single pink sheet at which the C.O. stared thoughtfully. It read as follows :

*" 1917, Dec. 17th, AAA 73rd Brigade wires AAA Following from GHQ AAA Begins AAA All pilots who have served overseas for six months or over to be returned to Home Establishment for training as instructors AAA ends AAA Please send in names by 6.0 p.m. of all pilots on your strength who have been in France six months AAA 181st Wing AAA."*

" That means we're losing the Starling," the Major remarked as he tossed the wire over to the Recording Officer. The latter read it and made a grimace.

" Looks like it. Who shall you give ' C ' Flight to, sir ? "

## AIR STORIES

"Damn 'C' Flight. Who's going to play the piano on guest-nights? That's what's worrying me! I must remember to ask the Pool to send us a musician. They've let our orchestra down badly lately. If we do get a decent man, someone comes along and pinches him for another job. Look how they took Crabtree away—the best violinist we ever had—just because he could speak German. Now they're pinching our pianist. We shall be left with only a trap-drummer and a piccolo."

He heaved a sigh at the responsibilities which weighed on the shoulders of the commander of a service squadron; then with a thoughtful frown on his face, passed out of the hut and made his way to the mess.

**T**HE Starling, otherwise Captain Oswald Sparling, together with the other members of his flight, was finishing a late breakfast—his second that day—and Major Cormley took a vacant chair beside him. The Starling greeted his C.O. with a cheery grin, being privileged so to do by reason of his long standing in the squadron.

"How's the Wing to-day, sir?" he asked through the interstices of a mouthful of toast and marmalade.

"Flapping as usual," responded the C.O. gloomily. "In fact they've given me a bit of a knock this morning. It's about that I want to see you."

"They're not moving us to another aerodrome before the Christmas party, are they? A bit thick if they are. I got two new records in Amiens last night—topping ones. One is that priceless thing about the Optimist and the Pessimist; the Babe and I are working up a parody on it."

The C.O. coughed apologetically. "As a matter of fact—well it's very awkward. . . . By the way, how long have you been out in France now?"

Sparling cast a surprised glance at the Major. "Oh, about ten months. Why?"

"The Wing are asking for a return of all pilots who have had over six months' service in France."

"What's the idea? Not giving us extra leave?" the Starling inquired hopefully.

The C.O. shook his head. "You've got to go home," he said.

The other's jaw dropped, and he stared at the Major.

"What? For good? Do you mean we're pensioned off?"

"No, no," cut in the Major hastily. "You're to go back to England to be attached to the Home Establishment."

The flight commander set down his empty cup with a crash that reduced it to fragments.

"Sacked, by heck!" he exclaimed bitterly. "Too old at twenty-two. Well, well! Youth will be served, but it's damned hard luck on us old fogies to be told we're not wanted—that we can't manage the work any longer. I suppose they're going to shove me on home-defence."

"Not exactly. I think the idea is that you fellows need a bit of a rest from the strain of war; also that your experience out here will be of great value to the training squadrons. They're going to make you into instructors."

Sparling lit a cigarette thoughtfully. "Instructors? I remember when I was a hun we used to think the instructors an awful crowd. Either they were always bragging about what they had done out in France, or else they were the sort who had never been there, and didn't intend to go if they could help it. Of course, they weren't a bit like that really. I've met some of them since out here, and they turned out to be quite human. . . . But, you know, I couldn't instruct. I'd be no earthly good at tooling round the air in a 2c, with a hun in the back seat, trying to show him how to do it."

"You'd soon get into it. And think how restful it will be to be away from Archie, and not to have to be constantly staring into the sun for Albatri. Why, man, you'll be a little tin god in England, with ten months in France and fourteen Huns to your credit."

"Hm, maybe, but I'd rather stay here, sir. After all, there is something restful

## MYSTERY OF THE MARSHES

about this life. Often there's only one patrol a day, and when that's done one can shoot off to Amiens and have a good bust at 'Les Huitres' or somewhere. England, from what one hears, is full of hot air and red tape, and that's a thing we're not used to in 154. You know, sir, there isn't another squadron in France to touch this. Not one of the fellows would willingly transfer to any other. You've made it like a home to me, ever since I came out as a raw hun in February."

"You were a bit raw, weren't you?" the Major chuckled, not unkindly. "You were our first replacement after we came overseas. Remember how I hauled you up at the office when you'd been here a week and told you you'd have to go to two-seaters if you didn't keep formation better?"

The Starling laughed. "Rather. You put the wind up me properly. And to think that now I'm the only one of the old crowd left. Is it absolutely essential that I must go, Major?"

"You don't think I want you to go, do you? It won't be the same place without your playing. I'll put in a special plea to keep you, but I'm afraid it won't do much good. It's too bad. First they take Crabtree, now you."

"It's funny we've never heard from old Crabapple since he left, isn't it, sir? Do you know what he's doing now?" Sparling asked as the Major rose to go.

"Haven't the foggiest. Some Secret Service stunt, I fancy. Probably translating German messages or something. He could speak the lingo like a Prussian. Lucky devil! I expect he's sitting in an office in the Cecil. Well! I'll make that appeal to the Wing, but don't be too hopeful."

"Tell 'em," said the flight commander hopefully, "that I'm the world's worst dud at landing, and would crash every training 'bus I took up."

But in spite of the Major's pleading, Captain Sparling was duly posted to the Home Establishment. A farewell binge was organised, at which the orchestra surpassed itself; the rendering of the

Optimist and the Pessimist was received with acclamations, and on the next day—in defiance of the traditional Arab's poetically silent departure—he bade his batman fold up his valise, and roared away to Amiens station in a Crossley tender.

## CHAPTER II

### Number "Ninety-One"

THE Cecil, that palatial building which housed the nerve-centre (some would say the brain-centre also) of the R.F.C., was just closing when Sparling reached its doors, on Christmas Eve after a rough crossing, and he was informed that the powers above would not reassemble until Boxing Day; till then he might amuse himself as he pleased. His home, away in the wilds of Yorkshire, was too far off to make a visit there practicable, so he collected his kit from Victoria and drove to Knox's hotel in Jermyn Street where he secured a room.

He felt lonely and miserable. All around him were gaiety and fellowship, but he, perhaps alone in all London, was a stranger among strangers. There was not, so far as he knew, a soul with whom he was even acquainted in the whole place.

He went to bed early, and fell asleep thinking wistfully of the glorious beano they would now be having in the squadron mess. Perhaps they would miss him. Not for long, of course. No one was ever missed for long. Life was too full out there to spare time for regrets. But to-night, at any rate, they would think of him—perhaps even envy him for being in England. Envy him! Gad! If they only knew how he felt.

He walked to Westminster Abbey in the morning and listened to the Christmas service, but his mind was far away. While the choir sang of herald angels, he was hearing in imagination the spatter of machine-gun bullets; the heavenly host he thought of took the form of diving Albatris, and the message they bore was not one of peace or good will.

He came back to the hotel for lunch. There were only two other occupants

## AIR STORIES

of the dining-room, a civilian and a soldier in lieutenant's uniform, and the waiter seemed to resent the presence of all three.

Sparling took a book in with him and read through the meal, but at times he kept hearing scraps of conversation from the table across the room. It was the repetition of a number that first caught his interest—Number 91. It kept recurring.

**W**ITHOUT intending to do so, he found himself listening to the conversation. The men were speaking in low tones, and one at least, with a slightly foreign accent. He heard the name of Branleigh mentioned, and remembered that there was an aerodrome there. It was somewhere in Dorset he thought. He tried to concentrate on his book, but without success; he found that he was more interested in the other occupants of the room. There was something intriguing about their frequent reiteration of that number.

"Ninety-one what?" he thought to himself as the waiter set the tepid Christmas pudding before him. And then a sentence came clearly across the room. It was the younger man speaking, the officer.

"Ninety-one said definitely it was to be a month to-day."

The other frowned and gave a quick "Ssh!" of warning, glancing across at Sparling as he did so, but Sparling was intent on his plate and apparently not listening, though actually he was turning over in his mind the import of what he had just heard.

So Ninety-one was a person. Strange, that. It was only convicts who were known by numbers, or privates, or members of secret societies.

He paused, fork in mid-air, as the idea struck him. These men, could they be spies? Were they a couple of units in that secret army which mingled with the British people and menaced the life of the nation? What ought he to do about it?

He glanced covertly at them. They were eating gorgonzola just like ordinary

people might, yet he felt sure he was not mistaken. One of them was a middle-aged man, inclining to stoutness, his sandy hair receding from his temples, his cheeks mottled with fine purple veins. He might have been a stock-broker or an auctioneer, thought Sparling. The other, in khaki, was younger, lean and tanned, and the flight commander noted that the left half of his upper lip curled in a curious way, giving him a resemblance to a snarling dog. A dangerous man to cross, judging by appearances.

He caught the eye of the older man and reddened. He saw the man lean over and whisper something to the other, who shook his head and smiled. Sparling felt they were talking about him, so, having finished his lunch, he rose and passed out. Perhaps he had been rude to stare. After all, he might be mistaken, but the reference to number Ninety-one had intrigued him. Ever since he was a boy he had wanted to serve his country in the Secret Service. When the war came he hadn't known how to set about it, and had joined the R.F.C. as the next most romantic way of serving his country. Here, perhaps, was a chance to do a little counter-espionage on his own. He would get into conversation with them in the lounge and try to make them betray their calling.

They joined him presently, and he made a tentative effort to break the ice by asking for a match, but the older man handed him a box in silence, and merely nodded when he returned it. Evidently they were not to be drawn.

He gave up his efforts for the time being, and went out into the cold raw afternoon. He had no definite objective, and was strolling up Jermyn Street when someone clapped him on the back.

"The Starling! By all that's wonderful. What the deuce are you doing here?"

It was "Chick" Elliot, into whose shoes he had stepped as commander of "C" Flight. Christmas Day began to take on a brighter aspect as he explained the situation.

## MYSTERY OF THE MARSHES

"You poor devil! Come along. There's half a dozen of the old crowd at the Hillmere. Old Saucepan's there, and Smithers, and Scottie, and Harling. Get your kit and join us."

"Are you sure there'll be room?" asked Sparling doubtfully.

"Room? Gad, yes! We're sleeping three deep already, but the old girl will push you in somewhere. She's never let 154 down yet."

It was a great reception that met Sparling when he entered the Hillmere, which had come to be the rendezvous of his former friends. They were all eager for news of the squadron, and he, in turn, was keen to learn how they had fared since they left France. Elliot was, he learned, instructing at Branleigh. Harling, after recovering from a crash, was on light duty at the Cecil. "Saucepan"—otherwise Dicky Sampson—was in command of a training squadron on Salisbury Plain. Scottie, as his sling testified, was still in a convalescent home in South London. Smithers was an instructor of instructors at Gosport. There were one or two others there, too, including Gault, an R.N.A.S. pilot from the Tripe squadron which had shared 154's aerodrome, who was now stationed at Calshot.

They sat and swapped yarns over the fire till time to dine, and then took a taxi round to the Savoy where Chick had booked a table. There they stayed until midnight, and after escorting Scottie back to his hospital with military honours, they returned to the Hillmere and held a concert until the small hours. It was only as he climbed into bed that Sparling remembered he had done nothing about the two spies.

**N**EXT morning the party broke up, the members drifting back to their various duties, and Sparling, cheerful now, though suffering from a certain lassitude which he erroneously attributed to the effects of the Channel crossing, reported at the Cecil, and was duly posted by a yawning Staff major to Gosport for an instructor's course.

Smithers appropriated him as a pupil,

and for a fortnight he received dual instruction in a Mono Avro, learning all over again the gentle art of doing splitair turns and rolls.

Smithers, the instructor, was a very different person from Smithers, the former flight commander, and abuse flowed freely down the telephones as Sparling muffed his cross-wind landings or overshot his forced descents. Smithers would take him up to five hundred feet, suddenly shut off the engine, and yell "Now land her!" And in nine cases out of ten Sparling made for the wrong field. He felt like a lower-third school-boy hauled into the head's sanctum for a faulty Latin prose as Smithers harangued him on the tarmac each time they came down.

What was the use of it all, anyway, he argued to himself. He had never had to make a cross-wind landing in France, and on the only occasion when he had had to make a forced landing—when a Hun had shot a chunk out of his petrol lead—he had been at fifteen thousand, with plenty of room to get back to a forward aerodrome.

The course came to an end eventually, and he passed out with a "B" certificate. He was given a week's leave, and posted as an instructor to Branleigh on the Dorset coast.

In the days when he himself was a hun, he had pictured the life of an instructor as one long round of glorious gaiety, punctuated by an occasional trip aloft with a pupil. It was nothing like that. To begin with, on the day after his arrival he was unceremoniously aroused by his batman at the gloomy hour of 6 a.m. to attend the physical drill parade. After breakfast came an instructors' meeting, then up to the sheds to the flight office to deal with forms and indents. Next, out on to the tarmac to begin instruction. Six new pupils had been allotted to him, and Sparling soon grew weary of tooling round the aerodrome calling "Keep her nose up. No, not too much. Left rudder. That's it. Keep the cowl level with the horizon. That's the idea . . ." and so forth and so on, *ad nauseam*.

## AIR STORIES

Then there was the business of dealing with offenders ; mechanics "crimed" for untidy uniforms or staying out after hours. In France their mechanics had been a splendid crowd. They had done their job with keenness and efficiency, and no one had bothered about whether their tunics had a spot of oil on them. These ack-emmas seemed a shiftless lot. Many of them were young boys with only a rudimentary idea of how to rig a 'bus or tend an engine.

Sparling hated it all. Once, when up with a pupil, a tank-bearer strap broke in the air, and on another occasion a carelessly-latched cowling-plate blew off and jammed itself in the centre-section, completely obscuring his forward view. He did in the undercarriage on landing, and received a sarcastic dressing-down from the C.O., Major Edderley. After that he took good care to inspect all visible parts before trusting himself up in a machine.

The C.O. himself seemed to have no personal interest in his staff. He was often absent for days together and, when at Branleigh, his chief hobby seemed to be night flying in a Camel he kept for his own use. Where he went on these trips after dark no one ever seemed to know, but as he was never away for longer than two hours, it was generally thought that he did not land anywhere. Rumour had it that he had a wife living at Southampton, and that he went out to patrol above the town in case a Gotha should attempt to approach the resting-place of his spouse.

Sparling found an instructor's work supremely dull. He longed for the old days in France, and but for the fact that Chick was there with him, he would have found it intolerable. The other instructors were decent enough, but most of them were content to have a cushy job in England. Had he confided to them his longing to return to active service they would have thought he was bragging, so he kept silent.

It wasn't the danger he was hankering for, though. It was the sense of comradeship and *esprit de corps*, which he missed. Here, when the work was

done, everyone went their own way. There were no jolly evenings in the mess. Binges were frowned on by the authorities. Everything was stiff and formal. Once he and Chick approached the mess piano and tried to start a sing-song. The result was not such as to encourage them to repeat the experiment.

### CHAPTER III

#### The Dweller in the Marshes

THE instructors' shifts at Branleigh were arranged in periods of twenty-four hours, and thus on alternate days Sparling was free from lunch-time to the following afternoon. Sometimes in these free times he and Chick would take a 'bus and fly down to the civilian aerodrome at Bournemouth and stay the night ; sometimes they would go into Southampton, but there was always a bother about getting leave as well as the fuss over coupons in the hotels. It hardly seemed worth it.

One amusement, however, they did devise. They would take an Avro and fly down to the marshes by the coast, a few miles from the aerodrome. Here there was an abundance of wild duck.

They would fly low over the marsh, one of them piloting the 'bus from the front seat, and the other, armed with a twelve-bore gun, perched precariously on the fuselage with his feet tucked under the safety-belt. As the duck took wing, alarmed by the 'plane, the pilot would give chase and bring the machine alongside the flock to give the gunner a shot. It was exciting sport and difficult. To bring down a plump mallard gave the "observer" almost as much satisfaction as to see an Albatros plunge earthward in flames. It had the additional advantage that one could eat the mallard.

One day Chick was in the front seat and the Starling was doing the shooting from the rear. A flock of duck rose wildly, and the Avro gave chase and drew alongside. A couple of barrels brought down the leader and another fine bird, and the shooter was re-loading



## MYSTERY OF THE MARSHES

when the flock suddenly wheeled in mass formation and streaked off seaward. Forgetting his passenger in the excitement, Elliot flung the machine over into a splitair turn to pursue the birds, and Sparling was almost thrown out. He saved himself by a miracle, but dropped the gun as he clutched at the cockpit side. Then, sliding down into the seat, he picked up the telephone mouthpiece and sent a stream of lurid invective into the ears of his startled friend.

"Kindly take a little more care in turning," was the burden, though certainly not the content of his remarks. "You almost tilted me into the swamp. I had to drop the gun to hang on."

"Sorry, old bean. We'll slip home and get my car out and run down to look for it. Mark the spot."

"Why not land here?" suggested Sparling. "There's a decent bit of ground against that hut. It's big enough to put an Avro on."

But Chick wasn't risking it. It might, as he pointed out, be water-logged, even though it appeared dry from the air. Accordingly they returned to the aerodrome and got out the little two-seater which Elliot sported, and were soon back at the marshes. Having taken the car as far as the road would allow, they left it and continued on foot over the rough track which wound seaward. At times they were on dry ground, at times leaping from tussock to tussock, while occasionally narrow single-plank bridges, half rotted away, provided the means of crossing the more submerged wastes.

The track evidently led to the rude shelter which they had noted from above. Its walls were simply blocks of turf, and it was thatched with corrugated iron, but its site was well chosen, for the ground around it was perceptibly higher than the general level of the marsh, and at all times except at high tide it would be comparatively dry.

"You could have put the 'bus down here perfectly well. There must be at least a hundred yards of dry surface," pointed out Sparling as they approached.

"I don't know so much about getting down perfectly well," replied his friend. "What about that?" and he pointed to a fence of barbed wire, attached to iron V-section posts, that ran all round the raised space.

"Curious," said Sparling thoughtfully. "Why should anyone want to fence off a patch of ground in the middle of a marsh?"

"Probably some villager grazes a cow on it in summer," suggested Elliot.

The Starling snorted. "I suppose he carries the cow here on his back," he returned sarcastically.

They had reached the fence by now, and looked round for a gate. There was none. The wires stretched in unbroken sequence round the whole enclosure.

"Curiouser and curiouser," quoted Sparling. "Mind you don't tear your bags as you get through."

They scrambled between the wires, but had hardly done so when the hut door opened and a man emerged and came towards them.

"What do you want?" he demanded brusquely. "You can't come here. This is private property."

THE speaker looked villainous enough in rough tweed jacket and waders, and with a week's growth of stubble on his chin, yet Sparling had the impression that he had seen the fellow somewhere before. He was still staring at him, trying to recall a former meeting, when Elliot spoke.

"Sorry if we're trespassing and all that, but we dropped a gun from a 'plane about half an hour ago. It must have fallen quite close to your—er—residence. Do you mind if we look for it?"

The man took his eyes off Sparling at whom he had been gazing in evident perplexity.

"Wait there. I'll get you your gun. Yes, indeed." He turned and strode back to the hut.

"Rum sort of johnny," commented Elliot. "Doesn't seem to want us near his hut. Wonder what he keeps there?"

## AIR STORIES

"Better ask him," suggested Sparling absently. He was still struggling to call to mind where he had seen the man before.

The man presently came back with the gun and handed it over. "Now clear out of this marsh. It is not healthy here—for you!"

Elliot took the gun, but Sparling made no move to go.

"What about our ducks? There's a couple down here somewhere, and we're going to look for them."

"The ducks you shot have gone up to Branleigh Manor. Lord Branleigh doesn't care for poachers. He said you might have your gun, but if it happens again he will take proceedings against you." The man turned and walked away without another word, and the two pilots made their way back to the fence, considerably damped in spirit.

THEY were climbing through the wire when a small white object in the grass attracted their attention. Chick, who was the nearer, picked it up and discovered it to be a sixpence with a neat hole in one edge.

"Someone's lost their luck," commented Sparling.

"Well, I found it, so the luck's mine now," his friend retorted.

"Rot. I saw it first—tell you what; the one who guesses nearest the correct date can keep it."

"Right! 1913," hazarded Chick promptly.

Sparling looked at the King's head as it lay in the other's palm.

"1910," he judged, and Chick turned it over with a flick of his hand.

Next moment he gave a gasp of surprise. "Look at this," he exclaimed, shoving the coin under Sparling's nose. "Someone's been debasing the coin of the realm."

Sparling looked at the reverse casually. He wasn't really interested; he was thinking of the man in the tweed coat. But when his eye fell on the coin he snatched it and let out a yell of surprise. Where the crown should have been was a smooth surface with only the

figures 9 and 1 embossed in the centre.

"What's bitten you now?" demanded Chick.

"Got it at last. I knew I'd seen that man before. Now I remember. It was on Christmas Day. Only he wasn't dressed like that then. He was wearing uniform, and he was shaved. It was his lip that struck me. Did you notice how it curis up at one side?"

"Yes. But how did the sixpence remind you? I don't see the connection," put in Elliot.

"This fellow was lunching with a civvy, a stout, sandy-haired fellow, at Knox's. I was the only other person in the room. I couldn't help hearing their conversation now and then, and they kept referring to a Number Ninety-one. By Jove! Now I come to think of it they mentioned Branleigh too. Chick, old man, I believe we've dropped into the middle of a German spy-stunt."

"Dropped in the middle of your grandmother's onion-bed," snorted Elliot. "Just because you meet a man you've seen once before, and find sixpence, you put two and two together and make about five hundred."

"But listen. I've just remembered something else. It was the older man who said it. He said, 'Ninety-one says it is to be a month to-day.' What day is this?"

"January the 23rd, Annie Dominoes 1918."

"Then, don't you see? Something is going to happen here the day after to-morrow. Number Ninety-one is evidently the big noise in their outfit, and he has been down here, probably arranging things. This sixpence is evidently his token. He obviously dropped it getting through the fence. Chick, I'm positive there's some dirty work afoot. We've got to do something about it."

"But what sort of things could happen in a place like this?" demanded Elliot, still unconvinced.

"Lots. That hut is only three hundred yards from the sea. It's an ideal place for a submarine to come in and land a

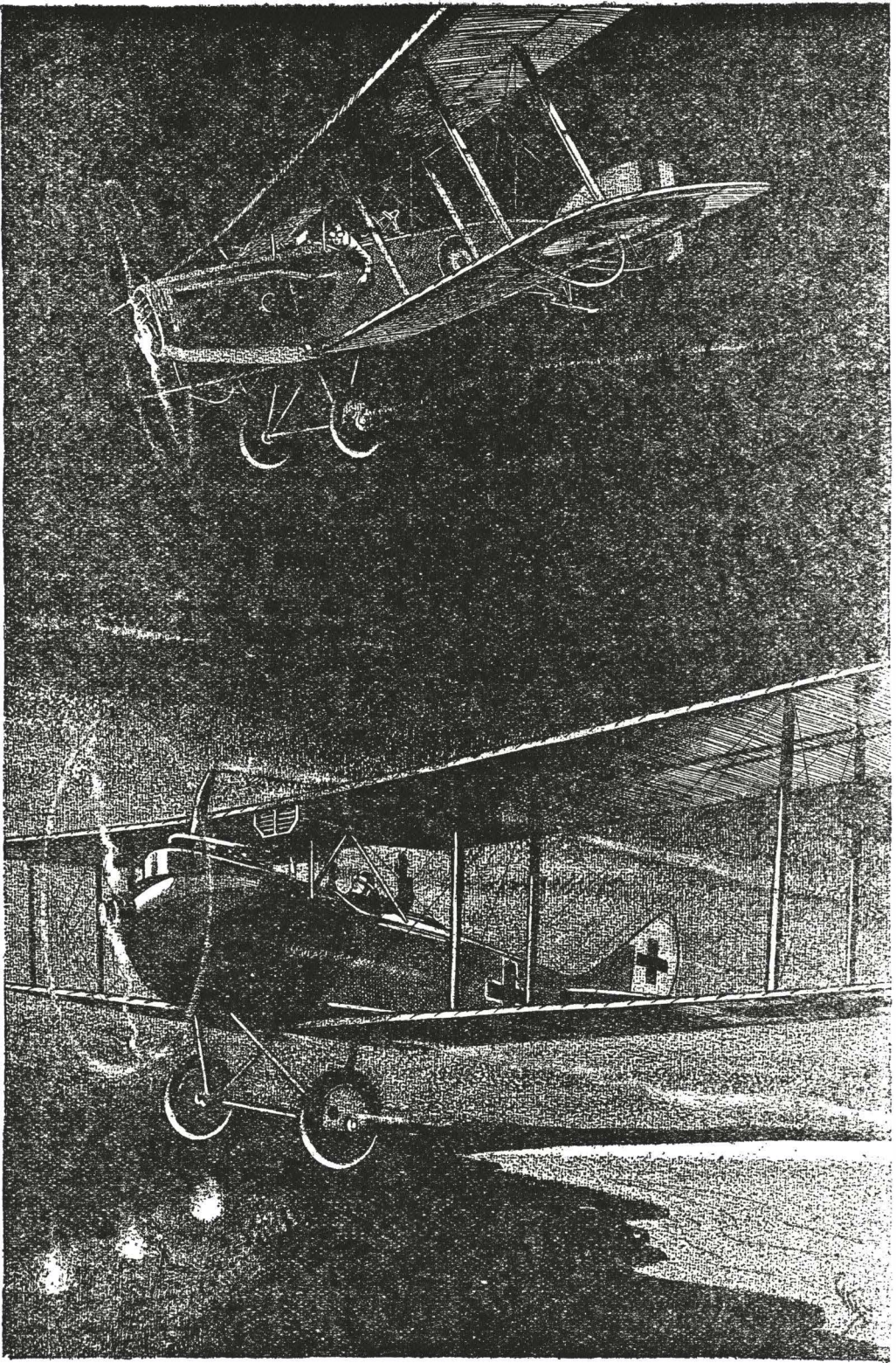

*Flying above the German machine, Sparling pointed downward to the marsh.*

## AIR STORIES

spy or pick one up. I don't mind betting that there is a track across the marshes down to the shore."

Elliot wavered. "It certainly seems queer—this lonely hut with a watcher to keep inquisitive folks off, and it's odd that that sixpence should have the same number that you heard them speak of. You may be right."

"Of course I'm right. What are we going to do about it?"

Elliot thought. "We'd better go and see the C.O. This business is too big for us to tackle alone. He'll know what ought to be done."

### CHAPTER IV

#### A Camel Flies By Night

MAJOR EDDERLEY listened to their story in silence, his impassive features giving no indication as to how he was receiving the account. When they had finished, he held out his hand.

"Let me see that sixpence," he said curtly.

"Sparling handed it over, and the Major examined it. A gleam illumined his cold eye as he noted the figures on the reverse of the coin. Then he slipped it in his pocket.

"My advice to you is to read less Deadwood Dick fiction and stick to your job. You go poaching on private preserves, and fall foul of a keeper. To excuse yourselves you doctor up a cock-and-bull story about German spies and secret tokens. Forget it. There's nothing in it beyond your own imagination."

They came out of the office quashed, and feeling thoroughly small. Chick was inclined to be resentful.

"There you are," he said. "I told you it was all bunkum."

"I don't believe it," Sparling responded warmly. "The thing hangs too well together to be merely coincidence. There's something fishy going on on that marsh, and I'm going to find out what it is. Are you game to come down to that hut in the dark and find out what's in it?"

Elliot shrugged his shoulders. "If

I don't come you'll say I refuse to be convinced, so I suppose I'll have to. But I'll bet you a quid there's nothing in it but gamekeepers' traps and such like."

So after mess they set out once more in Elliot's car and drove cautiously down to the terminus of the roadway. Then, armed with torches, they began the difficult journey across the marshes. By daylight it had been no easy task to avoid getting wet, but at night it was ten times more hazardous. Step by step they felt their way, often feeling the water seep through their shoes as they took an unwary step. Only by the continued use of their torches, which showed the wearing-away of the tussocks of sea-sedge and cotton-grass, could they make headway.

It took them nearly an hour to come within a hundred yards of the wire fence, and there they paused to hold a council of war.

"I don't suppose Twisty-lip will be hanging round at this hour," whispered Sparling, "but it's best to be careful. Mind how you get through the fence. I have an idea that it's connected to the hut by a wire of some sort. You noticed how the fellow came out as soon as we touched the thing? He couldn't have seen us, because there is no window on that side of the hut."

"You may be right," assented Chick. "Anyhow, lead on, and I'll be with you."

They crawled forward, shading the torches with their hands, for another fifty paces. The ground was firmer now, and they were just rising to their feet to make the last portion in comfort when a peculiar drone in the distance made them pause.

"Aeroplane," whispered Elliot.

"Edderley, going off on one of his night flips," affirmed Sparling. "He's coming this way."

Sure enough, in a few moments a dark shadow roared overhead and vanished seaward. Its silhouette, outlined against the stars, revealed it as a Camel.

"Wonder where the beggar goes,

## MYSTERY OF THE MARSHES

and what he's up to?" queried Elliot as they began to advance again.

Sparling had no opportunity to answer, for a sudden light appeared ahead, followed by an uprush of flame that danced weirdly in the darkness. They stood gazing at it in alarm.

"Marsh gas!" affirmed Elliot confidently after a few moments of startled peering. "I've read of it. It's quite harmless. Come on."

"Rot! That's a petrol flare. And look, there's another."

It was true. Light after light sprang to life, and in the glow a figure could be seen moving about methodically from one flare point to the next. At the same instant they heard the sound of the returning 'plane, the engine giving spasmodic explosions as the night-flyer throttled it down to glide in. They flattened themselves on the ground as it swept over, and they saw it come safely to earth in the little enclosure.

"How the deuce did he get over that wire?" asked Elliot petulantly. "He ought to have gone on his nose by rights. I'm going to investigate."

They wormed their way forward cautiously until they came to the edge of the enclosure, and then the mystery was at once explained. The whole fence lay flat on the ground, and careful searching with light fingers revealed the fact that each post was hinged at the base, so that by the simple drawing of a pin it could be made to assume a horizontal position. With the fence in an upright position no one would guess that the enclosure could be used as a landing-ground. With the fence laid flat it was comfortably large enough for a Camel to land.

The watchers lay still. They were too far off to hear any conversation that might be going on between Major Edderley and the guardian of the hut, but in the dying light from the flares they could see the C.O. lift four rectangular packages from the cockpit and transfer them to the man in waders, who carried them, two by two, to the hut.

It was Elliot who hit on the nature of the burdens.

"Petrol tins!" he whispered, and the other nodded. This was confirmation of his theory beyond a doubt.

"Let's crawl up to the back of the hut and try to hear something," suggested Elliot, now as keen as Sparling himself to indulge in spy-catching.

THEY wormed their way along the fence until they were directly behind the building, and then, gingerly stepping between the wires that lay in the grass, they tiptoed noiselessly up to the rear of the turf walls, and strained their ears to catch what was passing within.

The Major was speaking.

"... but I don't think you need worry, Baumann. I put them off the scent—told them you were a keeper. If they do come round here again I'll have them transferred to another station where they can't interfere."

"It was most unlucky that that pilot should have overheard me on the feast of Noël in London. That he should come down here and recognise me again is—how you say?—the very devil!"

"Yes, it was bad luck. But don't worry. By the day after to-morrow at this time you will be on your way back to the Fatherland. Number Seventy-three will bring you the papers to-morrow."

"*Das ist zehr gut...*" began the man whose name was Baumann, but they heard the other click his tongue impatiently.

"How often have I told you never to speak German while you are here in England."

"It is safe enough here on the marshes. I am always careful when in the village," Baumann replied.

"You were careless in your speech in London. Unless you look out you will be dropping a careless word in German among the villagers. Then it will be the firing squad for you, my friend, and that will not be pleasant."

The man muttered something inaudible, but Major Edderley went on.

"Now, I must get on. Tell me, how much juice have we here now?"

"Juice? Ha, ha! I did not com-

## AIR STORIES

prehend for the minute. You have the English idioms better than I. You mean petrol. We have . . ." Here he dropped his voice so as to become inaudible to the listeners, but whatever the quantity named, the answer seemed to satisfy the C.O.

"That is sufficient to re-fuel with. Well, I must be off. Come and give me a swing. And don't forget to raise the fences when I am gone and to connect the alarm-wire."

Their voices faded as they passed out of the hut door and walked across towards the Camel in the darkness. The watchers ventured on speech.

"Jumping Jupiter! This beats cock-fighting. Let's get off the ground before the fences are up. We mustn't be caught by the alarm." It was Elliot who spoke.

"Wait," whispered Sparling. "I'm going to have a squint inside that hut first."

Without giving the other a chance to expostulate he set off in the darkness around the turf wall, and Elliot was constrained to follow. Cautiously they crept round the side of the hut and peered in through the doorway. It was pitch dark inside and they could discern nothing. They might as well have stayed where they were for all that they could learn.

But Sparling was not to be daunted. Clutching Elliot by the arm, he drew him within the narrow opening and closed the heavy wooden door. Then, drawing his flash-lamp, he let a beam play quickly round the interior. One glance was enough. It revealed tier upon tier of petrol tins, reaching up to the roof and covering the whole floor except for a tiny space near the door: the interior was, in truth, an almost solid block of petrol.

"Sakes alive! There's enough juice here to float a battleship," ejaculated Elliot.

"At any rate, we know now why the C.O. comes out night-flying. It must have taken him weeks to cart all this stuff down here."

Swiftly and silently they withdrew,

just as the Clerget began to function with a sullen coughing. Before it had taken-off they were outside the enclosure and lying prone on the pathway. They waited until the 'bus had taken the air and the fences had been clicked into position, and as soon as the guardian of the hut had disappeared within, they got out their torches and made their way with many stumbles back to the road and were speedily on their homeward way.

## CHAPTER V

### A Trap for Spies

NEXT morning, being still off duty, they were dressing at the gentlemanly hour of 10 a.m., when an ack-emma knocked at the door of their joint sleeping quarters.

"Beg pardon, but you two gentlemen are wanted at once in the orderly room. The Major's been looking for you all over."

They finished a hasty toilet and made their way up to the office, speculating on what new development had taken place.

The C.O.'s hut was separate from that of his staff of clerks, and as they reached the door, their footsteps deadened by the soft ground, a voice came to their ears from within. Its tones were strangely familiar to Sparling, but it was the words that pulled him up short and made him motion Chick to be silent.

"Look here, Ninety-one. There must be no hitch. Everything depends on Baumann getting away to-morrow night."

The Major's reply came in peevish tones. "I tell you there will be no hitch. There was no need for you to see these men."

"It is better that I should see them. If they got ideas and started to interfere, it might make things damned awkward. I wish they'd hurry up."

The Starling had heard enough. He gave a cough and noisily pushed open the office door.

"You wanted us, sir?" he said, respectfully saluting.

## MYSTERY OF THE MARSHES

"Ah, there you are. Where the devil have you been?" Then without waiting for a reply he went on, "This is Lord Branleigh. He has been complaining about you shooting his wild duck and disturbing his game generally by flying low over the marshes."

"I'm very sorry, sir. We hadn't realised that it was private property. It was just a little way of enjoying ourselves in our spare time." As Sparling spoke he was looking at the Baron. There was no doubt that this was the same man whom he had seen lunching with Baumann a month ago. There was the same sandy hair, the same mottled cheeks. His eyes travelled down the figure before him, and he almost started as he noted, on the watch-chain slung across the corpulent waistcoat, a sixpence similar to the one they had found yesterday except that the number on it was "73."

His lordship was speaking: "I quite understand. I should have done the same myself at your age, no doubt. But it is most annoying for me, because I happen to be keen on ornithology. I'm trying to encourage several rare species of wild-fowl to nest on my marshes. They're very shy, and I am afraid they may decamp if they are disturbed. I don't like spoiling your sport. I realise that it must seem ungracious of me to forbid it, but I hope you will understand that I am not being merely officious when I say that I must absolutely forbid you to fly low over those marshes."

"Very good, sir. We quite understand." Perhaps there was a trifle more accent on the last two words than were really necessary, but the Baron let it pass.

"I shall be glad to give you both a day's shooting on more orthodox lines if you care to come along some time. There are a few partridges left, and we might get a hare or so."

They made their thanks with the correct degree of gratitude, and were about to go when the C.O. checked them.

"You quite understand that you are

not to go near the marsh again, either on the ground or in the air."

"Quite, sir!" The reply came simultaneously, and pilots withdrew together.

They walked in silence till out of hearing, and then Chick found expression in a low "Phew!"

"Pretty awful goings on," affirmed Sparling. "At any rate, we know three of the gang now. Did you notice the token on Seventy-three's watch-chain?"

"Spotted it straight away. What are we going to do next?"

"Go and see the Colonel," suggested Sparling.

"And be laughed at for a couple of fools? No. I've got a better idea. We've got this morning free to make our arrangements. Let's collect up as many of the old crowd of 154 as we can and collar the blighters ourselves." He went on to outline his plan, and Sparling readily agreed, with the result that in a short time, in an Avro and a Camel respectively, Sparling and Chick set out in different directions, and disappeared from Branleigh until lunch time.

CHICK arrived back first, and waited on the tarmac until his friend put in an appearance. When Sparling arrived he lifted a couple of heavy parcels from the rear seat and carried them carefully into the flight office. Then the two walked together to their quarters.

"Well? Any luck?" asked Sparling.

"You bet. I found Dicky Sampson, and he's willing to come in. Scottie is down there with him now, and he's fetching him along as well. How about the people you saw?"

"Smithers was as keen as mustard. So was Gault. I arranged to pick him up on the way here. I got Gault to let me have a couple of eggs in case we need them."

"That makes half a dozen of us, and as far as we know there are only three of them. We ought to manage. What do you think their game is?"

## AIR STORIES

Sparling shook his head. "We can only guess. Whatever it is it won't come off till dark. We'll hold a council of war when the others arrive."

NEXT afternoon—the 25th—just as the sun was setting a Mono Avro side-slipped down and made a three-point landing dead on the tarmac, and Smithers, with Gault in the passenger seat, climbed out. A few minutes later Sampson and Scottie disembarked from a Brisfit and the party was complete.

The six of them adjourned to Sparling's room at once, and the council of war began. First, Sparling gave an account of the events that had led to his suspicions, beginning with the incident in the Jermyn Street hotel, and Chick corroborated the story in its latter stages. The others listened in silence. When he had finished there was a pause. By common consent they all waited for the senior man to speak first. At length Sampson removed his briar and gave his opinion.

"You've some nerve to drag us down here to help you to arrest your own C.O. But I don't see any other way out. Edderley, as I happen to know, is a big bug with the authorities, and if you went to the General in Southampton he would only laugh at you. But there's no doubt you've hit on a piece of dirty work, and we've got to stop it to-night."

"But what do you think they're up to?" asked Sparling fretfully.

Sampson shrugged his shoulders. "Whatever it is, the danger is coming from the sea, I imagine."

"Probably a submarine is calling to pick up that Baumann fellow," opined the R.N.A.S. man.

"And to re-fuel at the same time," cut in Smithers. "Got a map handy? I'll bet there's a creek somewhere about where a U-boat could come in fairly close."

The map was hastily unfolded and, sure enough, several streams from the marsh ran into the sea in the neighbourhood of the little landing-ground. One of them especially, within a few

hundred yards of the hut, seemed particularly promising.

"But do submarines burn petrol?" queried Elliot; but no one seemed to know for certain.

"At any rate," stated Sparling, "we've got a line to go on. I propose that we divide into two parties. One party of four to go by land down to the marshes and collar Baumann, Lord Branleigh, and the C.O. as they arrive. Baumann should be there already, and the other two will roll along one by one. The other two of us to go by air and deal with the submarine—if there happens to be one. There is a good moon to-night. It rises about ten. We've a couple of eggs, and I've had bomb-racks fitted on my Avro."

This plan seemed to meet with general approval, subject to slight amendments. It was arranged that Elliot should lead the party across the marsh, and that Sparling and Smithers should take the air. Smithers, however, insisted on being allowed to do his bit from the air solo.

"One of you had better take the Bristol, then," advised Sampson. "She's fitted with guns, and they may be useful."

It was arranged also, that when the ground party had captured their prisoners they should signal to those above by means of a torch. This would give the bomber the cue to begin laying his eggs on the submarine, if any appeared, or alternatively to land and help to secure the captives. Each member of the expedition was to carry his Webley and a supply of cord for tying the prisoners.

The conference broke up to adjourn to the mess for dinner, and when Major Edderley had left the ante-room, Chick, as arranged, sauntered after him and saw him safely to his quarters which were in the same block as his own. Shortly afterwards the rest of the party followed on to Elliot's room, where the latter reported that the C.O. had gone to his cubicle, no doubt to prepare for his expedition.

After a final repeating of instructions,



## MYSTERY OF THE MARSHES

Elliot, together with Sampson, Scottie, and Gault, donned their coats and crept silently out to begin their journey down to the marsh, and the other two set themselves to wait, with the room door ajar, until the Major should make a move.

### CHAPTER VI "Sacked Again"

IT was not till ten o'clock that they heard Major Edderley come out and pass their door, and a short time later they heard the sound of the Camel's engine, and the roar as it took-off into the darkness.

Leisurely they donned their flying kit and walked up to the sheds. There was no hurry. The C.O. would be sure to have allowed himself time to confer with his fellow spies before the submarine, or whatever the vessel was, put in an appearance at the creek mouth.

They carefully placed the two bombs in position in the racks fitted to the Avro, and Smithers climbed aboard; Sparling warmed up the Bristol's engine, and five minutes later they took-off.

Taking the lead, Sparling led his little patrol north-east in the direction of Southampton Water. They had decided it would be best not to approach the marshes direct from the landward side, but to make a detour and come in from the sea so that, in case the land party had not yet secured all their prisoners, the spies would not be scared off. They turned south-east until they picked up the Spit lightship on the moonlit water, and then swung round and came down the Solent, flying at a thousand feet, about half a mile off-shore.

They cruised on half throttle as far as Hurst Castle without seeing anything suspicious, though the winking flares on the marsh told them that Number Ninety-one had in all probability landed. Then, turning again, they came up-wind, setting a course direct for the creek mouth.

Sparling was gazing intently down at the water, searching with keen eyes

for any sign of a U-boat breaking the surface. The moon was gaining height, and the shadows of the two 'planes flitted ghost-like over the calm Solent. He glanced at them idly, and then muttered an exclamation as he saw a third shadow on the water ahead, moving rapidly. At first, in the dim light, he thought it was some craft on the surface, but a second glance revealed it clearly as the outline of an aeroplane. He lifted his eyes from the waters and looked round. Yes. There, dead ahead and a little lower than the Bristol, was a machine gliding in towards the shore. At first he thought it must be the Major's Camel, but a second glance told him that here was no British machine, and a moment later the stranger banked round, and the moonlight caught the upper surface of the wings, revealing the sinister black crosses of the German Air Service.

So this was the scheme! Sparling saw it all. The enclosure on the marsh was a landing-ground where Hun machines might refuel after landing to gather information or drop spies. How cunningly it had been thought out! No one would expect a Boche 'plane so far west, and if anyone heard the 'plane pass over, it would be taken for one of the Branleigh machines returning home after a late flight.

Sparling looked round for the Avro. Clearly Smithers, too, had seen the Hun, for he was wagging his wings vigorously. He waited no longer, but shoved the Bristol's nose down and roared in pursuit of the enemy 'plane.

His attack took the foreigner by surprise, and he saw his tracers lashing the other's structure. The Hun twisted on to one wing and side-slipped out of the stream of lead that danced like fireflies around him, but he made no attempt to retaliate. Sparling, with the old joy of combat again stirring in his heart, was on his tail again in a flash. He noted that the machine was a two-seater—one of the new Rumplers, he thought—but the rear cockpit was empty. He had nothing to fear from the observer's gun. He was about to press the gun-trips for a final burst when he

## AIR STORIES

saw the pilot raise his hands in token of surrender. He checked his thumb—disappointed to some degree, yet exultant at his capture—and, flying above and beside the gliding machine, pointed downward to the marsh. Then, throttling back, he began to glide in.

Fishing out his torch, he sent a signal down to the watchers below, and had the satisfaction of seeing the answering flashes that told him all was well there. One by one the flares sprang up again as his friends kindled new supplies of petrol-soaked waste, until there was sufficient light to enable the 'planes to land safely. He watched the Boche come down. It was wobbling badly, and seemed to be overshooting. He saw the wheels touch heavily, then the Rumpler rose again, finally settling down, pancaking. It collapsed like a shot bird and turned over into the soft ground beyond the enclosure. Well, at any rate, they ought to credit him with capturing a Boche on English soil.

**S**PARLING banked round and glided in, touching the ground almost simultaneously with the Avro which had followed them down. In the light of the flares he saw a group round the hut door. Dicky Sampson was there with the rest of the crowd, and they were holding their three prisoners. Fine! Everything had worked according to plan. He waved to them, and Smithers and he ran over to the Hun machine from which the pilot had just extricated himself. He pulled out his revolver as he ran.

The man was swearing to himself softly as he stood looking ruefully at the ruins of his machine. As they approached he spun round: his back was to the moon and his face in shadow, but his voice had a familiar ring as it welled out from the bitterness of his heart.

"You ruddy young interfering fools. What the blazes do you think you're doing?"

Sparling gasped and swallowed hard, the triumph in his breast forgotten.

"Crabapple! I thought . . ." His voice trailed off into hopeless silence.

Only the phlegmatic Smithers was unmoved. "Gosh! It's Crabtree. Quite a reunion we're having. I wish to hell you'd been a submarine, though. I've a couple of pills on the Avro that would have tickled your throat."

The pilot of the Rumpler laughed. "Well, well. If it isn't the Starling and old Smithers. Just the sort of damn fool thing I'd have expected of you two."

Sparling recovered his speech. "How the deuce could you expect anyone to know you were not a Boche when you come tooling round in the dead of night plastered all over with iron crosses? What do you think you are, anyway?"

"At this moment I am one of the most trusted spies in Germany's secret service, specially charged with the task of dropping and picking up spies on Branleigh marshes."

Sparling's jaw dropped. "Gosh! How many more of the R.F.C. have gone over to the side of Jerry?" he asked.

Crabtree laughed again. "It's not quite as bad as that. You see, the spies I take back are specially primed with false information prepared for German consumption. There ought to be one waiting for me now—a fellow named Baumann. Lord Branleigh and a Major named Edderley—two of the finest men in the British Secret Service, by the way—look after him at this end and hand him all the dope they want him to retail in the Fatherland. He thinks they are brother spies. I'm afraid you've gone and mucked things up a bit. The fellow must have been scared off."

Sparling groaned. "We certainly have gone and ruined it." He rapidly explained the situation, and Crabtree looked serious.

But Smithers was not satisfied with Crabtree's story.

"How the hades do you come to be in the German Flying Corps?" he asked aggrievedly. "Are you a German spy?"

Crabtree nodded. "In name, yes. Actually, of course, I'm a British spy in Germany. You remember how they took me from the squadron because

## MYSTERY OF THE MARSHES

of my knowledge of German? They had this idea in mind, I suppose. Anyhow I had a course in technical German, and then was pushed in with faked papers through Switzerland. The way had been prepared for me there, and in less than a month I was put on to this job. The spies I bring over are genuine spies enough, but I bring over a lot of information at the same time, and take a lot of false stories back."

"Well, what are we going to do about it?" demanded Sparling hopelessly. "We've upset the applecart properly. You can't get back: not to-night. We might get the machine ready for to-morrow night, but what are we going to do with Baumann? We can't just let him go. He would smell a rat."

"He'll smell one as it is, seeing us talking together. He'll have to be sacrificed, I'm afraid. I daren't let him get back to Germany. There's nothing much wrong with the 'bus; a few control wires gone, and a smashed prop. I think. It can be patched up in a couple of hours. I shall have to report that Baumann did not turn up. Now come on, you fellows. We've wasted enough time. I'm afraid Edderley won't be pleased with you, but you've got to face the music."

MAJOR CORMLEY was in the Squadron office, dealing with the usual pile of hot air from the Wing. He pushed it over to the Recording Officer after a hasty glance.

"Sort that bunk, will you? I've a letter here from my beloved sister. She married Edderley, you know—'Clam' Edderley, supposed to be the most mysterious man in the R.F.C." He slit open the envelope as he spoke and settled down to read.

In a few moments he sat up and struck his fist on the table.

"Gad! Just listen to this. This is the funniest thing I've heard for weeks. Clam, you know, has been doing some espionage stunts lately—something tremendously cunning, by all accounts. Well, it appears that some of his own subordinates got the idea that he was a

pukka spy, and they got a bunch together and collared Clam and three others just as they were doing their little turn, and dished the whole programme: undid about two months' careful planning in five minutes.

"To make matters worse they had a genuine Boche with them whom they were carefully nursing. In the confusion, while Clam was ticking off the busybodies, the spy got away and shut himself in a hut full of petrol. Before they could get him out he had set fire to it and blown the whole place up, himself included."

"Your brother-in-law would be rather annoyed," suggested the R.O.

"Annoyed? I should smile! But that wasn't the worst. When the petrol store started to blaze, Clam and the rest did a bunk out of the way, but there were four machines close by that got doused in blazing petrol and were burned to cinders. One of them was a Boche Rumpier, and its destruction seems to have annoyed Clam more than anything."

"I suppose the fellows who caused all the trouble will get it pretty hot," said the R.O.

"I expect so." He glanced at the letter again. "Yes. The two ring-leaders—instructors in Clam's squadron—have been reduced one pip and pushed back to France."

He paused as a knock came at the office door.

"Come in," he called, and picked up an official form which he intently studied—upside down—for a whole minute before he looked up. He liked to impress people with the importance of his job.

"Well. What is it . . .?" he began, but broke off as he saw the two figures before him. He stared aghast.

"Come to report from the Pool, sir," said Sparling, saluting smartly.

"What the deuce brings you back to France?" demanded the Major, when he could speak.

"We got tired of being little tin gods, sir," said Elliot with a grin.

"Besides," added Sparling truthfully, "we were sacked again."

# A Modern British Fighter

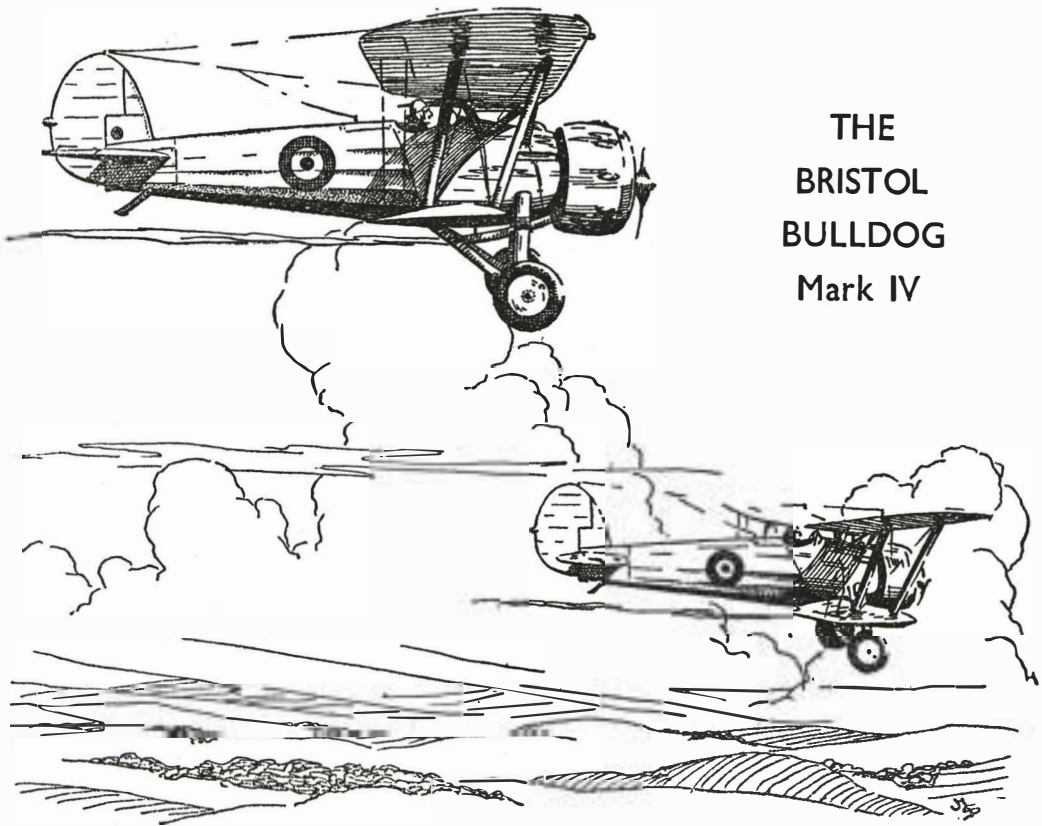

THE  
BRISTOL  
BULLDOG  
Mark IV

## A Description of the Latest Type Bristol Bulldog, with Full Instructions for Building a Scale Model

By JAMES HAY STEVENS

**A**S the second modern warplane in this series, the Bristol Bulldog Mark IV is particularly appropriate, for it is fully representative of the latest practice in the building of a fighting aeroplane round an air-cooled radial engine, whereas our last modern machine, the Fairey Fantôme (described in the March issue) was an example of the best possible arrangement with a liquid-cooled engine.

An added attraction for model makers is that the Bulldog IV is a well-tried old friend in its latest guise. The first Bulldog was produced by the Bristol Aeroplane Company in 1927, and was fitted with a 450-h.p. Bristol Jupiter engine.

A modified version, known as the Mark II, was produced, and subsequently adopted as the standard day-and-night fighter of the Royal Air Force. This type remained the standard machine in its class until it was recently rendered obsolescent by the introduction of the Gloster Gauntlet. At one time, no less than ten R.A.F. fighter squadrons were equipped with Bristol Bulldogs. Several Dominion Air Forces and seven foreign Air Forces also adopted it.

### All-Metal Construction

**T**HE Bulldog IV retains all the essential features of its predecessor, and in general outline resembles it closely.

## A MODERN BRITISH FIGHTER

Actually, considerable modification (suggested by points which have cropped up in service) has been made to the internal construction of the machine. Externally, the only apparent alterations are the completely cowled engine, the altered rudder outline and the ailerons on all four wings. As with the Mark II, the Mark IV is built mainly from high tensile steel strip and tube, the structure being fabric covered.

The single bay wings are of unequal span and chord. The petrol-tanks are situated in the upper plane, one on each side of the centre-section, and are contained entirely within the wing profile except for the drain wells. The ailerons are Frise-balanced; those on the upper and lower planes on each side are interconnected by streamline wires.

The fuselage is of the characteristic Bristol shape, the pilot being placed high where he has a good view forward and downward over the cowling of the engine. Owing to the fact that the cockpit is behind the cut-out in the upper plane, and that the pilot's eye level is along the chord of the wing, his view upward is also excellent.

The cockpit contains the usual formidable array of instruments which the modern fighting airman has to contemplate. Two Vickers machine-guns are mounted one on each side of the fuselage inside the front cowling, and they are synchronised to fire through the

airscrew. The guns are easily reached by the pilot for the purpose of clearing jams. Wireless equipment is carried in a locker behind the pilot's seat.

The undercarriage is a plain wire-braced cross-axle type. Shock absorption is by rubber blocks in compression with oleo damping, and Dunlop wheels with Bendix brakes are fitted as standard. These brakes are differentially operated for taxiing and are hand-operated simultaneously for parking.

### A Top Speed of 230 m.p.h.

THE standard engine is the Bristol Mercury VI S2 geared and super-charged air-cooled radial, giving a maximum of 645 h.p. at 15,500 ft.

The latest publishable performance figures for the Bulldog IV with the Mercury VI S engine are given hereunder, though it is understood that a still later and further improved version has a top speed of 230 m.p.h.

Max. speed, sea level	•	168.5 m.p.h.
"    16,000 ft.	•	208.5 "
"    20,000 ft.	•	204.4 "
"    30,000 ft.	•	176.8 "
Climb to 10,000 ft.	•	7 mins.
"    25,000 ft.	•	20 "
Service ceiling	•	30,550 ft.

The Bulldog IV, although not adopted by the British Royal Air Force, has been chosen to form the fighter equipment of the Finnish Air Force.

## BUILDING THE SCALE MODEL

### Full Details of Tools, Materials and Method of Construction

THE drawings and dimensions of materials given in this article are for a model to a scale of  $\frac{1}{72}$ nd. Should it be desired to make the model to some other scale, the drawings and dimensions will require altering accordingly. A scale of feet has been incorporated in the drawing, to facilitate transposition to any desired scale.

#### Materials and Tools

THE following materials will be required.—A block of wood  $3\frac{1}{4}$  by  $\frac{3}{4}$  by

$\frac{5}{8}$  in., from which to make the fuselage; a sheet of wood 6 by 2 by  $\frac{1}{10}$  in., to make the wings; a sheet of celluloid, thin aluminium or fibre composition material 3 by 1 by  $\frac{1}{16}$ th in. (16-gauge) for the tail unit; 18 in. of 20-gauge brass wire for wing struts, undercarriage and tail-skid; a coil of fine florist's wire for bracing wires.

For making the engine, airscrew and wheels, the recommended methods are given hereafter, the materials being, for the most part, scraps left over from

## AIR STORIES

the wings. Suitable models of the Mercury engine, a cowling with nose exhaust collector and an airscrew of correct size for a  $\frac{1}{72}$ nd scale model can be purchased at a reasonable cost from most toy or model dealers. Dunlop type wheels of the correct size are also obtainable. This is for the information of those modellers who feel they would rather purchase than make these rather trying details.

All the following tools will be necessary—unless the modeller is one of those talented people who can make a working model warship from empty matchboxes with only a penknife to help his ingenuity: one  $\frac{1}{4}$ -in. chisel, small plane, penknife, oil stone, small file (preferably half-round),  $\frac{1}{16}$ th-in. bradawl, fretsaw, small long-nosed pliers, plastic wood, tube of glue (cellulose glue is best for all-round use), a penny ruler measuring in 10ths, 12ths and 16ths of an inch.

### Method of Construction

NEW modellers should read and carefully digest the instructions before work is started. Veterans, and those familiar with the rudiments of model-making, are asked to have patience with what will appear boring and unnecessary detail in description of the processes concerned. When the instructions have been read and a general idea obtained of the model to be constructed, the actual work may begin.

Trace the side elevation of the fuselage, place the tracing on the side of the fuselage block and pinprick the outline on to the wood. The outline should then be lined-in in pencil. The nose of the fuselage block should be carried  $\frac{1}{8}$ -in. forward from the line of the rear of the engine cowling. The engine will be mounted directly on this, and the cowling will, of course, extend behind it, as shown on the drawing. Cut out the side elevation with saw and chisel, then mark a centre line on the top and bottom surfaces of the block. Draw the plan of the fuselage and cut out as before. Round the fuselage to an approximately oval section throughout its length. The appearance of the fuselage at this stage

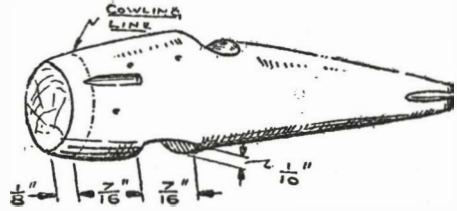

Fig. 1.—The carved fuselage block, showing cut-out for lower plane

is shown in Fig. 1. This figure also shows the size and position of the cut-out which must be made in the bottom of the fuselage to take the lower plane. Now is a good time to hollow out the cockpit and make the holes for the centre-section and undercarriage struts. Do not forget to cut a slot in the rear of the fuselage to take the tail plane; it is best to do this in the first process when the fuselage is still in square block form.

The outlines of upper and lower planes should now be drawn on the sheet of wood. Cut out with the fretsaw and camber with the plane. The wing section is slightly bi-convex; that is, the lower surface is convex instead of being flat, and of course, is not so heavily cambered as the top. Make the holes for the interplane and centre-section struts. The outline of the ailerons should be scored in with a bradawl and ruler. Make the dihedral angle by bending gently between finger and thumb after first heating the wood over a candle flame or in the steam from a kettle.

Cut the tail plane and rudder units from the  $\frac{1}{16}$ th-in. material, and camber them to a streamline with a file and glass-paper. When they have been shaped, score the outline of the rudder and elevator with bradawl and ruler.

Interplane struts are plain lengths of 20-gauge wire, which should be faired by paper as shown in Fig. 2a. The undercarriage vees are also made from this wire, and the method is shown in Fig. 2b. Wheels may be very conveniently made from  $\frac{3}{8}$ -in. diameter linen buttons. The button is first carefully slit open; the interior is then packed with plastic wood and the linen neatly

# THE BRISTOL BULLDOG SINGLE-SEATER FIGHTER

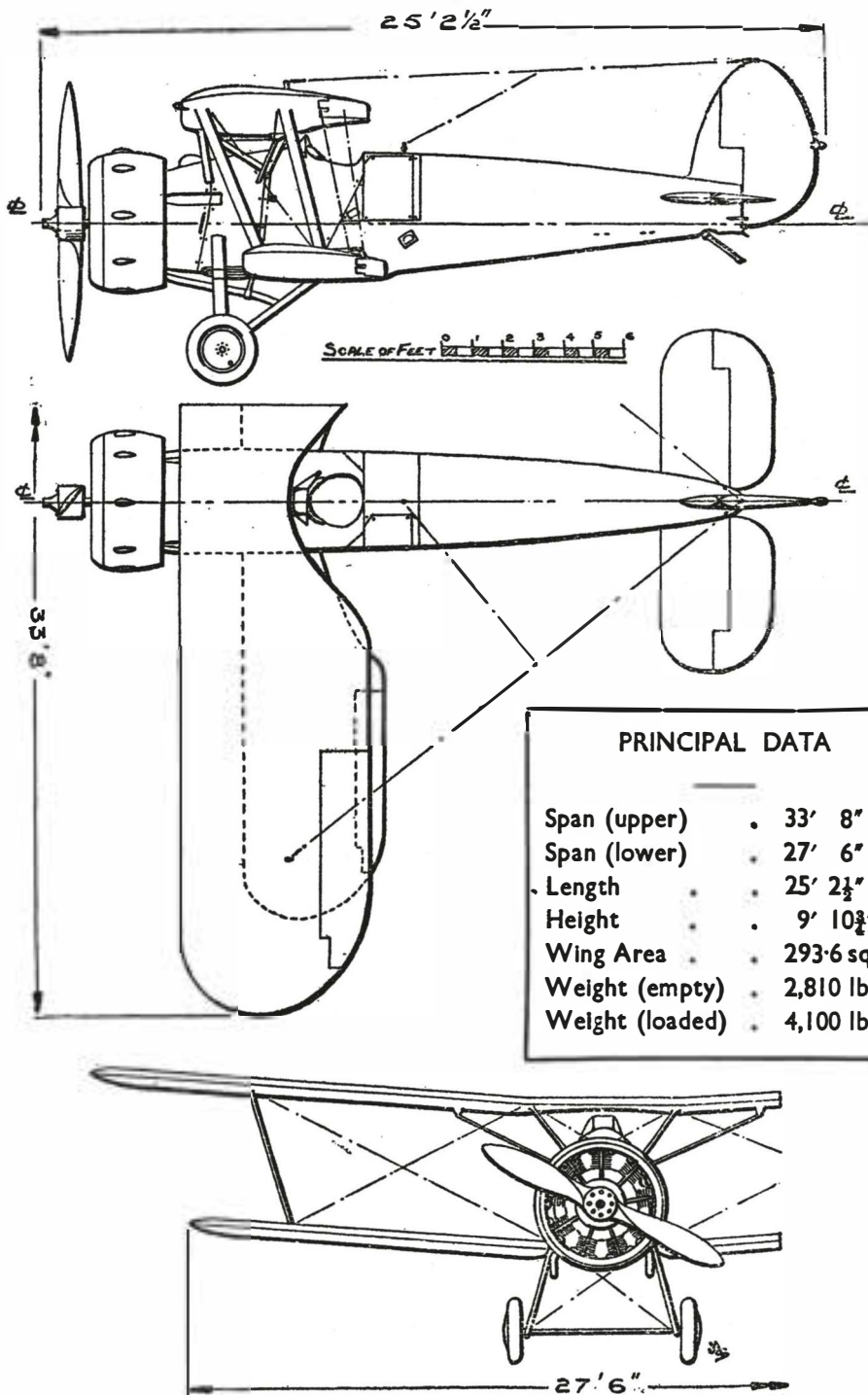

A Three-view General Arrangement Drawing of the latest type Bristol Bulldog Day and Night Fighter Biplane

## AIR STORIES

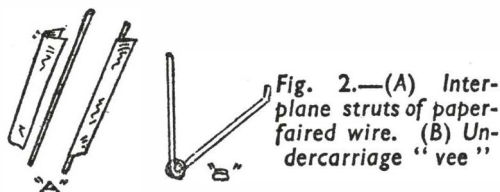

re-arranged. The plastic wood is allowed to harden and a hole is then drilled in the centre for the axle.

Fig. 3 shows the stages in making the engine by two different methods. The first method ("A") is to carve a solid block to represent the engine and cowling in one piece. This is fairly simple, but great care must be taken to make the cowling perfectly circular; of course, if the modeller has access to a lathe it will be a simple matter to turn up a job like this. The other method is to build up the engine by cutting a blank from a piece of  $\frac{1}{8}$ -in. wood, rounding the cylinders with a penknife and sticking on a small block of wood for the crankcase. The nose exhaust-collector is made from a  $\frac{3}{4}$ -in. diameter curtain ring. This ring is made to form the basis of the paper cowling. Careful workmanship will produce a good model by this method, but unless ample patience is available the modeller would be well advised to buy his engine and cowling—and save his temper. Now carve the airscrew from a flat piece of wood, as shown in Fig. 4.

### Method of Assembly

GLUE the lower plane into its slot beneath the fuselage, and allow the glue to set. Fit the centre-section and interplane struts and put the upper plane in place. Adjust all the struts for length, line up the planes for squareness, correct

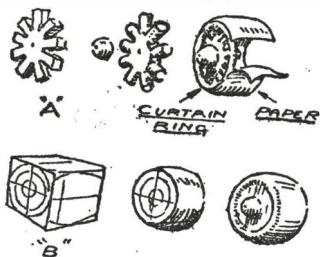

Fig. 3.—Two methods of making the radial engine and cowling

gap and stagger. When everything is satisfactory, glue and allow to set.

Fit the undercarriage vees; if extra detail is desired, streamline the vertical legs of the undercarriage with paper in a similar manner to the interplane struts, and adjust the track and height. Thread the wheels and axles, burring the ends of the latter with pliers to keep the wheels in place.

Glue the tailplane in its slot at the tail, and make sure that it is level. Then glue the rudder in place, taking care to see that it is vertical.

Fit tailskid, engine, exhaust pipes,

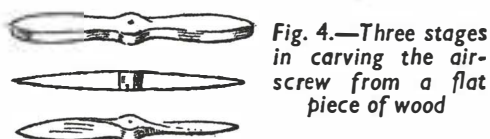

airscrew, windscreen and other details, and the model will then be complete.

If bracing wires are to be fitted, before assembling the model, small holes should be drilled about  $\frac{1}{16}$ th in. or  $\frac{1}{32}$ th in. from the various wing-strut holes; a bradawl will surely split the wood, and it will be advisable to use a fine Archimedean drill. Thread the wires, and secure with tiny wooden pegs and a spot of glue.

### Colour Scheme

THE experimental Bulldog IV is painted all silver except for black interplane and centre-section struts. R.A.F. identification cockades are borne on wings and fuselage. The Finnish national marking is a red Swastika on a white disc, carried on wings and fuselage.

Paint should be applied thinly and evenly. Two or three coats should be given—the first *along* and the second *across* the grain. The third should again be *along* the grain. The best paint for model work is that which can be obtained in 2d. or 3d. pots from most ironmongers. Use a No. 5 paint brush, and for any detail work a small liner's brush will be found useful.



# No. 55 SQUADRON R.F.C.

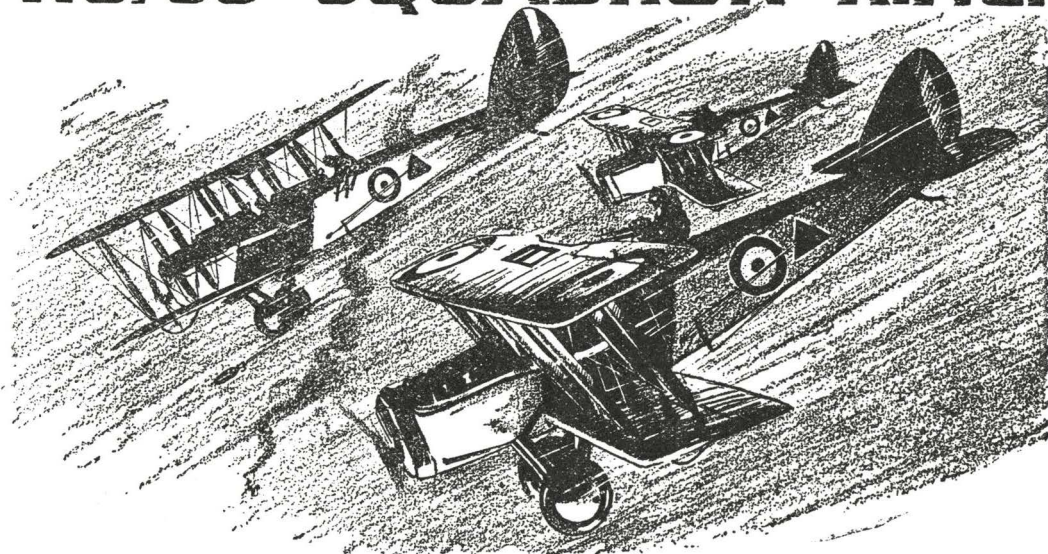

## A Brief History of One of the Most Famous British Bombing Squadrons of the Great War

By W. MACLANACHAN

Late of No. 40 Squadron, R.F.C.

THE widespread demoralisation of the German Army in the closing stages of the War, which finally ended in revolution and the internal disintegration of Germany, was no doubt greatly accelerated by the intensive bombing raids that were carried out on German towns on the eastern side of the Rhine and on the Rhenish towns themselves. The German people suffered not only the terror of the bombing, but were also thus given an all-too-convincing demonstration of the efficiency and morale of British airmen.

No. 55 Squadron took a prominent part in these long-distance bombing raids, a duty which it had carried out with signal success since its formation in the second year of the War. Formed originally at Castle Bromwich, Birmingham, in April, 1916, the Squadron, by March, 1917, was up to fighting strength and equipped with D.H.4's, the largest of our bombing machines at that time. The flying personnel were posted to France, and,

for three weeks after their arrival at Fienvillers, the pilots and observers spent their time studying the "lie of the land" and making practice flights.

More realistic work was soon to begin, however, and both before and during the battles of Arras and Vimy, the Squadron was engaged in bombing the enemy's towns, aerodromes and important strategical positions between Cambrai and Valenciennes. This sector included Douai, near which Richthofen had formed the first of his *Jagdstaffeln*, and it was not long before 55 Squadron was made acutely aware of their proximity to this doughty fighter. At that time, the German fighter machines were much superior to ours in speed, and as our scouts could not carry sufficient petrol to escort the new pilots on their bombing and photographic raids, the heavy bombers had to face, without escort, the insistent attacks of the pick of the German fliers.

Despite this great handicap, which was to cost them dearly, the Squadron

## AIR STORIES

carried on, bombing Valenciennes, Bohain, Douai, Abscon, with conspicuous success. At the end of May, the Squadron moved north to Boisdingham, just west of St. Omer, where their activities were directed against Tournai and Roubaix. During the battle of Messines, these pilots did great work in bombing opposing German aerodromes, releasing between forty and sixty 20-lb. bombs on each flight attack, Major Baldwin, the officer commanding the squadron, taking an active part in many of these raids.

### When the Raiders were Raided

**T**HROUGHOUT the summer the Squadron accustomed itself to resolute and steady work. The skill of the pilots and the expert machine-gun fire of the observers soon commanded the respect of the German fighters and, although there were frequent combats, many cases were reported of enemy scouts refusing to attack the bombers, preferring to reserve their fire for less formidable opponents.

Although illustrating only a part of the Squadron's daily work, one or two incidents in their record at this time stand out as being of historical importance. The first was the bombing of Gontrode aerodrome, from which the Gothas regularly took-off to carry out their demoralising daylight raids on London. No. 55 Squadron paid this aerodrome a surprise visit, and considerably altered its appearance and utility by depositing twelve 112-lb. bombs on the landing-ground and hangars. Further raids were made in September and October, on one of which twelve 112-lb., thirty-two 20-lb. and a hundred-and-ninety-nine 7-lb. bombs were dropped on the German base. Railheads and aerodromes formed the usual targets for these raids, and as the Germans began to dread the accuracy of the "55" bombers, they increased the strength of their defences. Beginning with sporadic attacks of single scouts or small flights, the defenders soon increased their formations to eight and even twelve strong in the hope of putting an end to these devastating and costly attacks. In fights,

however, they discovered that the now-experienced pilots and observers of "55" were still more than a match for them.

By the end of 1917, the efficiency of the Squadron had increased to such an extent that they were given the task of carrying the war into Germany itself. Until November, the bombing had been carried out on Belgian and French localities well on the German side of the lines. Having had painful experience of the futility of lone bombers attempting to fly great distances into enemy country, the Squadron now adopted proper flight formations. For the purpose of these daylight raids the Squadron moved to the aerodrome at Ochey, which they shared with No. 100 Squadron (a night-bombing squadron flying F.E.2b's), and No. 16 Naval, equipped with Handley-Page night-bombers. From there, successful raids were launched on Saarbrücken, Pirmasens and Mannheim. Near the latter town was the Badische Aniline Fabrik's works at Ludwigshafen, one of the largest chemical and explosive works in Germany, and on Christmas Eve two formations of British bombers dropped their entire complement of bombs on objectives round this factory, two good hits registering on the works themselves.

These successful attacks on the enemy's munition factories were most encouraging to our pilots and demoralising for the Germans and, time after time, works round Karlsruhe were bombed with serious results to the enemy. But this new British venture was not without its rousing effect on the defenders, and the aerial defences of these important centres were rapidly strengthened. Anti-aircraft gunners of proved ability were sent south from the northern sector of the line, and scout formations of ten and twelve machines did their best to harry the invaders.

The D.H.4's carried sufficient petrol for from five to five and a quarter hours' flying, and as many of their objectives were over two hours' flying distance away, the pilots had no petrol to spare on engaging in scraps. In a dog-fight the engine appears to drink petrol at twice its normal rate, and one

## No. 55 SQUADRON R.F.C.

dog-fight for a D.H.4 would inevitably have meant a forced landing, through petrol shortage, on the wrong side of the lines.

Few pilots who have not experienced it can appreciate the nervous strain and the tenacity that is required for a long-distance bombing raid. For between four and five hours the machines are flying over hostile country, to the constant barking attention of anti-aircraft shelling and the onslaught of enemy scouts. Despite these, the concentration of the pilots must be focussed on reaching their objective—leaving their defence to the ability of their observers.

The heights from which both photography and bombing raids took place were between ten thousand feet and twenty thousand feet. For some time the German scouts were unable to take an active part in fights as high up as nineteen thousand or twenty thousand feet, owing to both the Albatros and the Halberstadt finding their ceilings at about nineteen thousand feet. When the new Fokker arrived, however, the D.H.4's, by then equipped with 350 h.p. Eagle engines, met a desperate resistance. Sitting cramped in their forward cockpits, the pilots of 55 Squadron could see formations of from twelve to thirty scouts climbing with steady determination to intercept them. Often the Germans, faced with the deadly fire of nine or ten double-Lewis guns wielded by the D.H.4 observers, would hold back and content themselves with half-hearted attacks at several hundred yards range, but occasionally the bombers would encounter German fliers of different calibre. Such fighters were determined to come to grips and, getting above the D.H.4 formation, they would dive straight into the midst of the deadly fire of the observers. Under these circumstances, the British pilots would proceed steadily in formation, trusting to the skill of the observers to ward off the attack.

But the price for the victories thus gained was high, and all too frequently the bombers returned home riddled with bullet holes and with their observers dead or wounded. Amongst those who won

great distinction for the squadron at this time were Captain Farrington, Captain Beater, Lieutenant Heater (an American), Captains Silly, Walmsley, Stevens and Grey and Lieutenant Jones.

### An Exchange of "Prisoners"

**T**HROUGHOUT the spring and summer of 1918, 55 Squadron carried on its devastating work, bombing Offenbourg (an important rail junction), Buhl, Mannheim, Darmstadt and Ehrenbreitstein, with Cologne and Coblenz as "extras." The fighting was fierce and, despite the many victories won in combats, the toll taken by the Germans for these raids was severe.

Occasionally something amusing would happen. On August 14th a raid under the leadership of Captain D. R. G. Mackay was carried out on Offenbourg. On the way back the German scouts began collecting round the D.H.4's and, before the lines were reached, between twenty-four and thirty fighters were persistently attacking the bombers. Two of the enemy were completely destroyed and two more were sent down out of control. During the fight a German bullet pierced the water-pipe of Second Lieutenant Dunn's engine, forcing him to land near La Maticuelle. One of the Germans, believing he had an easy capture, followed the D.H.4 down and, in an attempt to complete the "capture," tried to land near Second Lieutenant Dunn. Unfortunately, the German crashed on landing, breaking several ribs and, to his consternation, discovered that he was on the wrong side of the lines. The French promptly took him prisoner.

The Germans determined that, as the valiant efforts of the British pilots and observers nullified the attempts of their own fighters to stop the raids, their own bombers would, in turn, retaliate upon the aerodromes of the squadrons that were causing so much damage. Accordingly, one evening in August, the Germans came over in force to attack 55 Squadron's aerodrome and camp at Azelot. Very little damage was done to either, the only bomb that might have shaken a few of the British bombers with

## AIR STORIES

a little of their own medicine, proving to be a "dud."

In addition to this retaliation, the German fighters were reinforced, and in September and October "55" were met by flights of thirty to forty Fokkers and Halberstadts. Their casualty list rose rapidly, but the raids were continued with unabated vigour.

No. 55 belonged to that illustrious branch of Britain's air arm known as the Independent Air Force, and in September one of their special duties was co-operation with the 1st American Army. Bad weather prevented flying during most of the attack on the St. Mihiel Salient, but on and after September 14th both reconnaissances and bombing raids were carried out in support of the troops.

Afterwards, long-distance bombing raids were resumed on Cologne, Frankfurt and a munition factory in the Black Forest. But the weather conditions were bad and, often for days on end, it was impossible to send a flight out. But if a flight formation attack was impossible with the bad visibility prevailing, single machines might, it was thought, get through to their objectives, and to test this theory Captain Mackay carried out a valuable experiment. On October 15th, with Second Lieutenant Ward as observer, he set out for the German aerodrome at Frescaty and reached his objective, despite the fact that at times the weather was so bad that they had to descend to within fifty feet of the tree-tops to ascertain their whereabouts. One of the Zeppelin hangars was situated on this aerodrome, and Captain Mackay succeeded, at point blank range, in dropping two bombs into it, and a third on one of the aeroplane sheds. At the same time his observer directed a fusillade of Lewis-gun fire on mechanics and horses at the end of the aerodrome. The machine returned intact. Such an exploit, however, was only possible when performed by a pilot who knew the neighbourhood perfectly, as, with only his compass to guide him through thick banks of cloud, the dangers of losing his way and being forced down were considerable.

### Attacked by Thirty Fighters

AS the winter and the end of the War approached, the weather became steadily worse and only periodically was the Squadron able to execute an effective raid. On October 31st, however, six machines bombed Bonn, two others re-visited Frescaty aerodrome, while two more dropped their complement of "eggs" on Treves. Again, on November 3rd and 6th, No. 55 Squadron's machines were successful in crossing the lines and, on the latter date, the Burbach works at Saarbrücken and the adjoining railway were hit. On this raid no fewer than thirty Fokker D.7's and other scouts attacked the formation, and the bombers had to fight for every mile of their way back to the lines.

Except for one other concerted attempt to attack Cologne on the 10th, no other mass attack took place, and on this final effort Captain Mackay failed to return. He had been hit by "Archie," but his observer, Gompertz, managed to bring the machine down and was taken prisoner—the day before the Armistice.

Few squadrons can equal, and none can rival, No. 55 in the spirit with which both pilots and observers carried out, from 1916 to 1918, their tedious yet highly dangerous task. In the summer and autumn of 1918 the Germans took heavy toll of the D.H.4's, and throughout the five hours they spent over the lines on a raid—often going more than a hundred miles from the Allied trenches—the machines were constantly harried by anti-aircraft gunnery of no mean order, and attacked by experienced fighters flying the fastest and best-armed machines on the front.

Though officially a bombing squadron, the number of aerial victories won by No. 55 Squadron would have done credit to a scout squadron, and it is high tribute to the skill of those who wielded the double Lewises in the back seats that the D.H.4's of this squadron could always be relied upon to spread consternation in the air as well as devastation on the ground.

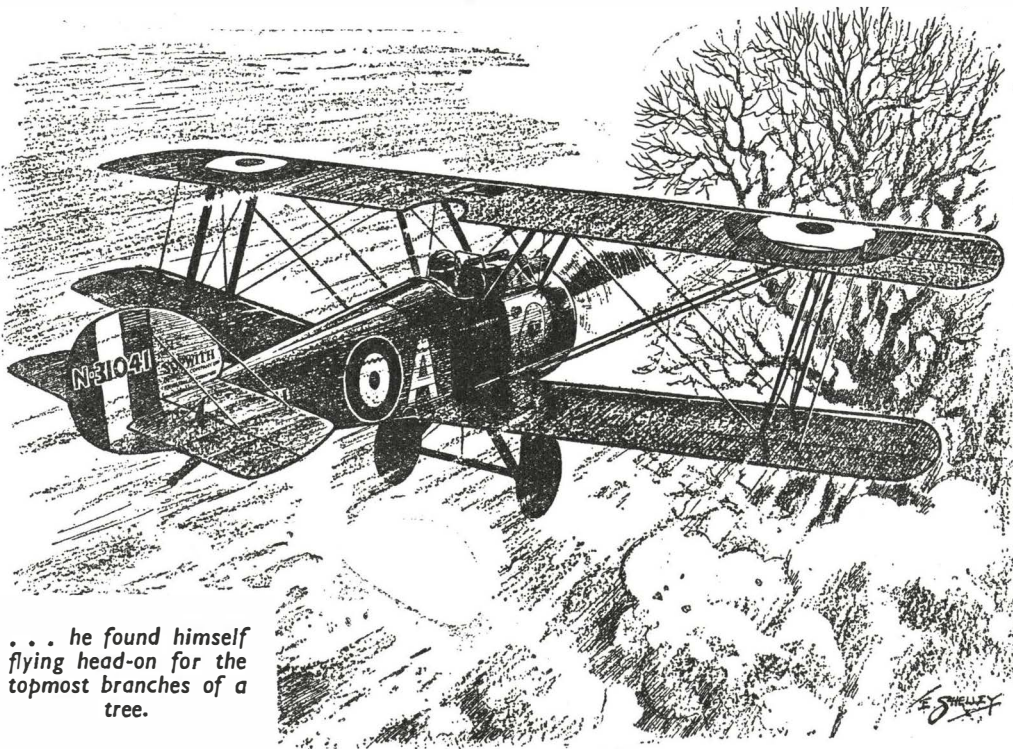

... he found himself flying head-on for the topmost branches of a tree.

# VISIBILITY LOW

Confidential Reports to Wing Described Second Lieutenant Victor Low, R.F.C., as "Lacking in Powers of Observation," and Certainly a Pilot who Goes out on Patrol in a Biplane and Returns Home in a Triplane is Either Extraordinarily Unobservant, or Exceedingly Fortunate

By G. M. BOWMAN

## CHAPTER I

### A Diet of Tripe

**T**HE Fokker triplane tilted its propeller skywards with the effect of being hauled up by an invisible, high-speed windlass; which was an unpleasant habit peculiar to "Tripe."

Immediately beneath it, "Fizzy" slammed-over in a half-roll and kept his tail down, at the same time thumbing a pair of Bowden levers in the middle of his stick spade-grip; which was a habit peculiar to Second Lieutenant Victor Low when exchanging pleasantries with German triplanes.

The effect of it, as a manœuvre, was

neat. A triplane's rocket-like power of climb usually took it out of any Clerget-Camel's range of shooting in something under half a second. For, at anything like height, a Camel's power of moving up a bit further was limited, to say the least of it.

There had been times when "Fizzy" Low had said a great deal upon the subject, and had taken a considerable time in the saying. For the fault of a stutter was half the reason for his nick-name. Then came the glad day when he thought of the half-roll gag—after which he let his two Vickers' guns do all the stuttering necessary on the subject of triplanes.

They spluttered now, and "Fizzy" got

## AIR STORIES

the flick of a red tail through his ring-sights and stood on his head, thumbing industriously. Wafts of stinking cordite blew back into his face from the labouring propeller. A hot brass cartridge-case bounced against the end of his snub nose and spun away down, with the rest of the shower, into the misty void below.

Whereupon "Fizzy" followed. To use his own expression, he slid out of that half-roll "like a fat lady falling off a 'bus," and plunged down giddily towards what the weather-conditions indicated was the earth. Directly the dive gave him full control, he came howling up again, caressing the end of his nose and looking round with watering eyes for the next instalment of scarlet trouble.

About a thousand feet higher and away to his right, he saw the rest of the squadron doing their little bits for England, Home and Glory—and he grinned slightly.

Jacko had ordered everybody on to a diet of tripe, more than a month ago; in fact ever since Mr. Fokker's little three-planed scouts had appeared and started making a nuisance of themselves. But now Jacko was certainly getting his belly-full. Soon, "Fizzy's" grin widened as he saw Captain Jackson, his revered squadron-commander, charge at a triplane, which hopped-up like a flea, out of the way.

But he could not watch the antics of the general fight for more than a second or so. He had his own private affairs to attend to, and he knew that, just now, he had not got home a fatal burst.

"Fizzy" reasoned, out of long and bitter experience, that if you wanted to see the father and mother of all wounded tigers, go and put a bullet-burst through a Fokker tripe where it didn't matter much—and watch the result!

At the moment, no kind of results seemed to be coming his way, which surprised him for he thought that the least he had accomplished was to tear-up a couple of scarlet elevators. Above him, to the right, half a dozen Camels were trying to persuade a Fokker squadron of equal size to go home and give up ambi-

tion. But the German, by temperament, is stolid and not easily convinced. . . .

"FIZZY" looked round for his own spot of tripe in the sky above, saw nothing, but then gulped with delight when he spotted it, diving at a gentle angle, already about two hundred feet below.

"By golly," breathed "Fizzy, "I must have pipped him bub-bub-better than I thought. I could've sworn th-that I only——"

"Fizzy" dived. He put his nose down, kept his engine going full-out in complete disregard of designers' instructions, and delivered himself towards the Fokker just like the legendary bright star which fell from the grace of Heaven.

It was a fall from grace in good earnest, for such a move was flatly against the express orders of Squadron Commander Jackson.

Jacko believed in keeping his men together as much as was reasonably possible. For the wily Hun, in these high-pressure days of 1918, was fond of tricks. He kept people hanging about behind a fight to pick-off stragglers and those who adventured on a chase too far.

"Fizzy" didn't think about that now. At Wing Headquarters, there was a confidential report about Lieutenant Victor Low which described him as a good officer and an excellent fighting pilot, with five observed victories to his credit. At which point the gilt left the general report-gingerbread in a paragraph which described Lieutenant Low as being "deficient in the art of map-reading and generally lacking in powers of observation."

At the moment, however, "Fizzy" was observing that Fokker, observing it coming closer and closer towards his ring-sights as he tore down the sky. He opened fire before he got within range so that he could steady-up the deflection of aim caused by his movement of the stick gun-controls.

But the Fokker chose that moment to dive steeply, too. It swerved away to the left and shot down at a much greater angle than a triplane usually dared to

## VISIBILITY LOW

take. "Fizzy" swallowed splutteringly and corrected direction to follow suit.

He was swallowing rather painfully because he had come down from eighteen thousand to just over eight thousand feet at well over two hundred miles an hour.

But, although he found himself plunging through drifting mist after the next four or five seconds, his heart was beating high. For if the triplane went on at this pace much longer, it would fold up. That was the one point about tripes. If you could "wing" them and make them go in off the top board, they started shedding wings. And once you had them on a diving-angle from above, they were cold meat in your sights directly they began to pull out.

But the Fokker pilot did not seem quite so bent on early suicide as his first movements had indicated. He swerved away to the left in the full flight of his wild dive, and at about four thousand feet—he suddenly disappeared!

Disappeared clean into a thick bank of drifting mist. Inside that mist he would, as the swearing "Fizzy" knew full well, pull his shuddering and whining machine out of its headlong career before the fuselage and wings started to part company. From which point, he could fly safely home to supper and get his twisted tail repaired at leisure.

## CHAPTER II

### Down in the Fog

"FIZZY" swung over to the left, too, and went down into that mist with both nose and temper smarting. He badly wanted another Hun, and he'd been so sure of that one! Lately the lads of the squadron had been exercising their senses of humour at his expense. Just because he had twice got separated from a flight in bad weather conditions and landed to ask his direction, they had been pleased to laugh like hyænas.

They had taken a well-known phrase out of the daily weather report and turned it round, to christen him "Visibility Low." From Visibility it had shortened down to "Vizzy," and from that by

reason of his stutter to "Fizzy," or just plain "Fizz."

Jokes about his habit of getting lost had grown, in the way such jokes do. A story drifted about that he had once joined up with a German squadron, and flown happily along with them under the impression that they were his own friends—until someone started to shoot. . . .

A wild exaggeration, of course. He had once made rather a dangerous mistake about a Pfalz two-seater under the impression that it was a friendly Bristol. But the jokers of the squadron always went too far. There was that other idiotic yarn about his having strayed blindly over a German "Big Bertha" gun just when it was firing—about the shell hooking him up with a part of his shattered machine, so that he was only able to kick clear of it and pull off a forced landing, when he had arrived over Paris! The story went further, including his reputed landing through the roof of a Turkish bath and into the lap of a nude French general, whom he thereupon asked the nearest way to Bethune.

But "Fizzy" had grimly decided that these stories were not worth thinking about, even whilst they were actually running through his furious mind.

The only way to stop that kind of fun-and-games was to notch-up a damned sight better innings than the jokers, and so put them to scorn.

But tripes were by no means easy. Scores were pretty low all round, these days—in the days, as a matter of historical interest, before the Bentley-engined Camel arrived in France to give all triplane-pilots a headache,

"Fizzy" eased up as he roared along through thick fog and pushed his goggles back over his forehead. Jacko's orders, especially aimed at himself, about keeping close touch, were utterly and completely forgotten. Somewhere about here that tripe had swung round and was swooping for home. It couldn't be very far away. "Fizzy's" altimeter showed three thousand feet, and, watching his compass, he swung round due east in the direction of the Fatherland.

But altimeters have an uncomfortable

## AIR STORIES

little property of only registering from the altitude at which they are set. "Fizzy's" altimeter had been set at his home-aerodrome, west of Bethune, where the height above sea-level was about four hundred feet. And now, whilst under the strong impression that he was somewhere east of La Basse, he was in reality crossing rising ground of the German back-area beyond Lens, which topped sea-level by very nearly one thousand feet.

Every man to his trade. On more than one occasion "Fizzy" had heatedly pointed out to his long-suffering squadron commander that he, himself, might not be very good at maps, but his job in life was that of a fighting scout pilot, not a guide for a damned Cook's tour. . . .

"Fizzy" flew on, exasperatedly searching for his lost Hun amongst the wreathing mist. He almost pondered whether t'were better to have seen a Hun and lost him, or never to have seen one at all.

Then he saw a jagged, scarlet flash which seemed to occur immediately beneath his right wing-tip, and which disappeared immediately in an obese spectre of thick, black smoke. At the same time, the Camel figuratively stood on its left ear, and a howling wind tore past "Fizzy's" head, carrying a hail of metal fragments which cracked through fabric and struts, rang sharply on the engine-cowling and whined away un-musically.

"Fizz" righted the machine with a startled, instinctive action and curved away from that A.A. shell-burst before he realised that his engine had stopped firing altogether. There were one or two ear-splitting bangs as petrol-gas "caught" in the exhausts, then nothing at all, except the nerveless clatter of the valves and the hiss of the idling propeller.

"Dah—dah—blast it!" gasped "Fizzy," "what the hell——"

Frantically he stared down beneath the dashboard at the tangle of pipes below the cockpit. He half-expected to see a petrol-lead smashed through by a lump of shrapnel. He slammed over the tap of his two-way tank and fiddled with the switch and engine-controls.

But nothing happened.

"Mag!" breathed "Fizzy," wishing to heaven that that useful adjunct was within sight, so that he could know the worst. "I'll bet it's the mag. There was a tut-tut-ton of stuff flying up into the engine from that A.A.——"

As he pondered this dismal fact, the machine suddenly lurched down with the spineless action of a falling pancake, owing to the fact that it had been flying flat and losing speed at the same time. "Fizzy" let it drop, moving his stick forward to "feel" the lift back again. One or two thudding bangs sounded from different directions, yet at the present moment he was not worrying. An "Archie" battery had evidently sound-ranged his height to a nicety, but with his engine silent they had lost him now. Anyway, the altimeter was still showing nearly a thousand feet of height, and if only this mist would clear a bit, he thought he might have a chance of seeing the lie of the land and trying to glide for the lines. Not much hope of course, but his engine *might* pick-up. Such lucky things had happened before. He felt for the natural gliding-angle by the pressure on the stick, and wondered vaguely whether they gave you anything to eat when you were a prisoner of war.

Then in a wild moment of frenzied movement, he wondered if he had lost his way to the extent of crossing the Atlantic to America! For something loomed up out of the mist like a ghost, and he found himself flying head-on for the top branches of a tree.

And outside America, he knew of no trees reputed to grow to heights of about eight hundred feet, together with other tall stories!

**L**IKE the proverbial old lady who saw a giraffe for the first time, "Fizzy's" first instinct was one of disbelief. He thought his eyes must be playing him tricks. But as there was an actual rattle and smash of twigs against his under-carriage as he swerved away, he realised that the trees were real enough. Indeed, he nearly slammed into a second one, an instant later, and realised that he was



## VISIBILITY LOW

almost scraping the ground as he yanked his machine on to a level keel.

Miraculous though it seemed, he had actually reached the floor, with his altimeter still brazenly showing another six hundred feet of elbow-room! Through the thick mist on his right hand side he realised that there was a dense wood, into which he had avoided crashing by a matter of inches.

And for the life of him he could not remember any wood of large dimensions to the east of La Bassee. The only one he could call to memory was far to the south, a damned, nasty spot in the back areas beyond Lens where the Hun kept a highly efficient Ack-ack battery. Everyone was careful to give that place a miss, with the exception of the night-bombers, who plastered it whenever there was a lovers' moon.

"Dud—dud—damn!" spluttered "Fizzy." "I must have missed my way."

IT was a nasty moment—the nastiest, apart from the moment of sudden death—which any war-aviator could experience. In the latter part of the war, Germany was not credited with very kindly treatment of prisoners. "Fizzy" had heard pretty grim tales, and his face was white and set as he brought the stick back to make a landing, and felt at the side of his cockpit for the Verey pistol hanging there in its clips. He made a fair three-pointer, and the machine rumbled to a stop with the propeller dancing asthmatically.

But, although he had the Verey pistol held ready, "Fizzy" was not calling it a day, yet. He saw now that one side of the engine cowling had been ripped and half-battered off by that hail from the A.A. shell. There was room for him to grope a hand through to the magneto, behind the engine. He knocked his belt undone, scrambled out on the wing and knelt by the engine, gasping as his groping fingers touched shimmering-hot steel.

But the gasp was followed by a surge of relief. For the magneto was there in its proper place, sound and untouched. "Fizzy" ran his fingers over the contact-breaker cover and felt for the main lead to the distributor ring.

He felt only a ragged end! In short, he found the trouble simple enough in itself, ironically simple, since he had been brought to earth merely by the severing of one wire which could be rejoined in a matter of minutes.

But those minutes were denied him. A sudden shot sounded from out of the mist by the forest edge, and he jerked his head round to see the dim forms of a couple of men running. Their small, peakless caps showed "Fizzy" only too clearly that his last vague hope was gone. He had not strayed back on to his own side of the line. These were Germans, and very businesslike Germans at that.

It was all up.

"Hell!" gasped "Fizzy" and jerked half upright, reaching forward with his Verey pistol to fire its blazing phosphorus down into the cockpit and set his machine alight, in accordance with the regulations for any pilot stranded in enemy territory. But as he did so, one of those running men slid to a standstill and levelled a rifle. There was a crack, a muffled spurt of flame, and "Fizzy" jerked against the cross-wires as he fired the Verey, with his shoulder stinging like the devil.

The blazing ball of phosphorus left the pistol mouth, struck the fuselage fairing and ricocheted at a wild tangent, falling almost into the path of the nearest man, who swerved and fell sprawling.

"Fizzy" fell too. The sting of that bullet had put him off his balance as well as his aim. He slipped on the smooth plane, came down awkwardly, and fell flat on his back on the wet ground.

Instinctively he bounced to his feet, grabbing at that aching shoulder. The mist was now glowing lividly to the blazing, hissing Verey light which flamed on the ground. Evidently it annoyed the man with the rifle, for he fired again, and a second bullet whistled with sharp viciousness close by "Fizzy's" right ear.

"Fizzy" turned and ran. He plunged for the safety of the fog and the cover of the trees. For, except for the empty Verey pistol, he was unarmed, and that German marksman seemed to be in no mood for taking prisoners.

## AIR STORIES

### CHAPTER III

#### The Secret of the Woods

**I**N the uncertain gloom, "Fizzy" ran headlong amongst the trees. He tripped heavily over a tangled bush, picked himself up again and plunged on almost weeping.

Another minute, just one minute, and he could have made a rough join of that broken mag-lead. He could have swung the propeller and got off again. It was ghastly, devilish bad luck.

As he ran, he passed a perspiring hand inside the neck of his shirt, found his wound and gained some comfort from the fact that it was only a flesh injury, although his shoulder hurt like the deuce and his arm was numb.

At the moment, "Fizzy's" strongest hope was that he would suddenly stray amongst a group of unarmed German privates, to whom he could surrender himself without a chance of getting shot down on sight. He no longer had the Verey pistol, even, and he did not believe that the ordinary, stolid German private was a savage.

Then in the misty gloom he suddenly found that he was treading on nothing, and went shooting headlong down a drop of perhaps twenty feet.

The side of that drop was muddy and sloping, so that he only got a shaking. But then followed the surprise of his life, for as he picked himself up at the bottom he realised that he was standing on a wide, flat bed of concrete.

And in the middle of the concrete was the most enormous gun he had ever seen, or ever expected to see !

At the moment it was lying flat on its ponderous mounting with the muzzle close to the ground. Scattered about beneath that muzzle was an array of ropes which had great, mop-like contrivances at their ends. There were buckets of oil ; indeed puddles of oil lay everywhere beneath the muzzle of the enormous weapon, which "Fizzy" judged to be just about twice as long as any naval gun he had ever seen on a warship.

At which moment, the whole amazing

truth dawned on him, and he blinked dazedly.

This was Big Bertha !

This was one of those terrific and carefully-hidden long-range guns with which the Germans had lately sent shells screaming ten miles up into the air over an eighty-mile distance, to land amongst the crowded streets of Paris, itself. Hitherto, the only known facts about such guns were the bursting shells that daily thundered death and destruction amongst the Parisian crowds.

But here in this wood, wherever it was . . .

"Fizzy" saw the cleverness of the whole thing, as he began to discern objects more clearly. The concrete gun-bed had been laid carefully around growing trees, which stood close to the weapon, itself, and so screened it from the air. Batteries of A.A. guns were posted all round within the wood and were there for the purpose of keeping all raiding aircraft high, so that there would be no possibility of close observation.

And the lowered muzzle, together with the oily gear below it, showed that the crew had been "pulling-through" in preparation for the evening's "shoot."

High amongst the branches above, thick reed-matting was draped for fifty yards or so all around in order that the enormous flash should not show. Back at the base of the gun, three eight-foot black shells stood ready on trolleys for loading into the breech.

From somewhere close by, the voices of men suddenly drifted to "Fizzy's" ears, together with the angry shouts of one who was plainly an officer. The reason was clear. The gun crew had all rushed towards the forest edge, attracted by the glare of the Verey light and the shooting. Now they were being ordered back.

"Fizzy" turned and ran full pelt. He went up the side of that twenty-foot slope with the speed, if not the grace, of a leaping deer. For one thing, he knew as an absolute certainty that, if it was found that he had as much as seen that mighty gun, he would be shot out of hand. At the best of times the Germans had no desire to share their scanty food supplies

## VISIBILITY LOW

with any further prisoners. And this they could deal with as a clear case of spying.

At the top of the slope, "Fizzy" went headlong through the trees, thanking heaven for the thick mist, even though it caused him to fall over unseen objects and cannon heavily off solid trunks. For it gave him his only hope.

Outside this wood, was the clear, open country. And in that open country he would at least have a fair chance of being taken as a prisoner of war without execution, since he was unarmed and not on forbidden ground.

**M**EANWHILE, the woods seemed to be interminable. "Fizzy" did not realise that, in spite of collisions with trees, he was actually doing what most people do in a mist, and was making a semi-circular path which was bringing him back in the rough direction of the point at which he had entered. As was only natural, he was out of the wood and clear of the trees before he had any idea of it, owing to the fog. He came out at a point about five hundred yards beyond his machine, which was now the centre of a highly-interested crowd of officers, with a man in a flying helmet sitting in the cockpit and fiddling with the controls.

All of which meant nothing in Lieutenant Victor Low's young life, for he couldn't see it owing to the fog. He didn't know that a careful drive was already being organised through the depths of the wood with the object of ferreting him out, or that he had already passed within a few feet of one of the armed searchers.

But now, as he was groping his way along, breathing heavily, he suddenly saw a vague shape ahead which caused him to leap aside and go sprawling on to a shoulder which felt as though it had been impaled on a red-hot poker.

In spite of the pain, "Fizzy" was on his feet almost in the same instant, half-doubled up and expecting a bullet. But none came. The shape resolved itself into the dim outline of an aeroplane, obviously deserted,

"'Strewth!" exploded "Fizzy," amazed out of his cautious silence. "It's a tripe!"

A triplane it was. A red Fokker triplane, svelte and airworthy-looking, with a faint shimmer rising from its still-hot Mercedes engine.

"Fizzy" saw the point at once. The tail-plane of that tripe was spattered with bullet holes—his own bullet holes! Quite obviously this was the machine he had been chasing. Its pilot had landed in the mist, hoping that his enemy would sheer off, and meaning to make repairs at leisure. Meanwhile, of course, that self-same pilot had run off with all the rest of the local inhabitants towards the Verey glare and the sound of shooting which had greeted "Fizzy's" own arrival. No doubt he was still keenly interested in examining a practically undamaged British Camel.

No one, not even the jokers back at his home squadron, had ever questioned "Fizzy's" courage. He crept forward now with something suspiciously like a grin at the corners of his mouth.

"He wasn't clean out of control," he mused. "He was flying all right. I bet he came down because he got a control of some sort shot off and didn't want to risk fighting in that state. *But*——"

"Fizzy's" heart leapt recklessly. The engine of this machine was hot, it ought to start at the first swing. And then, although it was undoubtedly damaged, it would still fly; it still offered him a chance of getting clear away! Of course he'd get plastered whilst crossing back over his own lines, but he could fly high and then come down, apparently out of control, and make a landing on a road in the back areas, where nobody would be likely to shoot.

"Fizzy's" heart bumped uncomfortably behind his tunic as he ran forward, reached up over the side of the cockpit and pulled up the switch he found just inside. Then he jumped round the three-decked front wing, and with his one good arm reached up for the propeller to pull it against compression. It was as he did so that he heard muffled, crashing sounds from the wood close by and the calling of

## AIR STORIES

voices as the searchers spread out about their work.

"Fizzy" yanked, and the propeller came over rather reluctantly. He was raising his hand to try again when one of the cylinders fired weakly. There was an asthmatic "ponk," then a dull, faltering succession of "ponks," each weaker than the last!

Franctically "Fizzy" dived back round the machine and flung himself at the cockpit, for he realised that the throttle was much more nearly closed than it had looked! He dived down into the cockpit for it, and pushed it almost full open as he was heaving his body up. Fortunately the hot engine took this sudden acceleration in a roaring, thundering mouthful. "Fizzy" tumbled down into the seat, pushed the engine control open to its fullest extent and hardly dared even to breathe, as the light little machine surged forward and gathered speed.

The fog was a blank wall in front of him. He had not the faintest idea if he was charging straight into the trees or in the opposite direction. He heard the crack of a rifle from somewhere far away and suddenly caught sight of vague figures almost directly in his path.

It was hopeless to turn. His only possible chance was to yank the stick back and hope to wrench her off the ground in a staggering jump; though he wondered whether he'd wipe off the undercarriage when she bounced down again.

She did not bounce. Indeed she came up in answer to that yanked stick so swiftly that the unprepared "Fizzy" cannoned his nose up against the wind-screen with alarming force. He had forgotten he was in a triplane, with its amazing powers of climb. The figures, gesticulating wildly, disappeared like a dream below him, but, even so, he thrust the stick forward again convulsively, for he feared a loss of flying speed and a crash.

From below there was a faint sound of firing, and his right wing seemed to shudder slightly. But with what he judged to be an air-speed-indicator showing a hundred and forty kilometres an

hour, the gasping "Fizzy" started to climb in good earnest, and bored up into the fog just as fast as his prolific number of wings could carry him.

And he was yelling with delight.

He had set out to get a tripe that day—and he had got one in real, good earnest. Now, once he had got it back, once he could clear the lines and land it somewhere in safety, the squadron jokers would have to laugh on the other side of their faces. What was more, there was the fact of that gun, that Big Bertha. He had spotted it. He, alone, knew where it was placed in the wood east of La Bassee.

## CHAPTER IV

### The Camels are Coming

**T**HROUGH thinning wreaths of mist, "Fizzy" finally cleared the fog drifts at roughly five thousand feet, and found a clear but dull sky. At first sight it seemed to be empty, but then "Fizzy" yelped like a puppy as he saw half a dozen machines, tiny but unmistakable, making for the horizon about five miles away.

That was Jacko and the rest of them, going home! Evidently the Fokker attack had sheered off; it was too much to hope that Captain Jackson and his followers had been able to down the lot. But, in any case, "Fizzy" slammed-over and went after that departing Camel flight with a grin on his face and a merry stave on his lips. He would not dare get too close to them of course. But to save himself trouble, he would merely follow at a respectful distance and allow them to guide him back to the home aerodrome, near which he could make his landing.

"Fizzy" hugged himself in high glee. This was going to be great fun. He was imagining the look upon dear old Jacko's face when he landed.

In which moment, imagination very nearly turned into reality, and "Fizzy" gave a startled gasp as he suddenly realised that the Camels ahead had made a very neat group Immelman and were coming back straight towards him, their combined speeds making the rate of

## VISIBILITY LOW

approach something like two hundred and fifty miles an hour.

For a moment "Fizzy" was so stunned that he could hardly move. At the beginning of that moment the Camels ahead had been thin black outlines touched by flashes of silver. At the end of it they were large, vicious-looking machines which seemed to be roaring right on top of him like dragons.

An exaggeration of startled senses, of course. "Fizzy" recognised Jacko from his strut-pennants and decided that his revered squadron commander must suddenly have gone mad to make such a sudden and purposeless move. Then, as he wrenched the triplane up in a fierce climb, he saw tiny livid, red splashes from Jacko's own guns. And he realised that the position was very difficult indeed. Jacko was a fighter, a damned fine fighter who never would give up. Now, having got to close quarters with a Fokker, he would keep with it until a verdict was arrived at.

And the worst of it was, as the frantically half-rolling "Fizzy" realised, he daren't shoot back himself. His only chance was to bunk, but how to bunk in anything like safety, with one of the very best on your tail, and five more sitting round, ready to take an interest in the proceedings, was more than he could imagine.

It was in that moment that "Fizzy" had cause to give hearty thanks to Messrs. Fokker and Mercedes, a thing he had never expected to do throughout the course of his life. The tripe was an alarming little thing which had tricks that nearly turned his hair white. But it *would* go straight up on the prop., and it *would* turn on the proverbial tanner.

Upside-down at the top of his half-roll, "Fizzy" saw Jacko thundering up beneath, saw him deflect to the left and kicked on right rudder and bank. The result being that he came down out of that half-roll in the opposite direction that Jacko had expected. And having come down out of it, "Fizzy" dived just as hard as he felt he dared do. He screamed away down into the depths and decided to make for the heart of Germany.

Surely the squadron would not follow him too far, he might still have a chance of shaking them off and getting back to the lines when they had gone.

With his air-speed indicator somewhere in the region of two hundred miles an hour, he pulled up out of the dive and used the momentum to carry him up into a climb which, he hoped, would make an end of the Camel pursuit. But to his horror the entire formation kept steadily after him. They climbed at a long angle so that he knew that he would only run into their bullets if he tried to turn and dodge back. Jacko, ahead of the rest, was still plodding stolidly on his trail.

"Fizzy" almost wept, and then nearly fell out of his machine when, down below him, through a break in the fog, he saw something that he simply couldn't believe. He saw ragged lines of trenches running across the earth like a livid scar. It was idiotic—it was impossible! According to "Fizzy's" own calculations, he was being driven back into Germany and was at least forty miles from the lines at this moment.

"FIZZY" began to feel as though he was going light-headed, and eased-down to a lower altitude whilst still going full-out, to try and see more. He had about a quarter of a mile lead on Jacko, and unless anything went wrong he could hold it.

Then, through another fog-break, he saw those scattered trench lines again. There was no mistaking them.

"Fizzy" gave it up, and dived. He shot down, heading straight for British territory. As he went, he knew he was taking a deadly risk, for a Camel could hold together far longer, in a much steeper dive, than any triplane could manage. Indeed, by the time he had dropped down to a thousand feet and was making for home over No Man's Land, there came a muffled rattle from immediately behind, and a whining hail passed over "Fizzy's" head.

Fiercely he bowled over into a turn. The whole thing was touch-and-go now. There was not the slightest hope of making Jacko recognise him, his only

## AIR STORIES

chance was to dodge, and to keep away from the fatal bullet-bursts until at last he could get his machine on to the ground, any-old-where in the British lines. And he knew that once it was landed, Jacko was far too good a sportsman to shoot a "sitter."

Yet grim death hovered about every move he made to get down on that coveted side of the lines. With cautious, almost fiendish skill, Captain Jackson headed-off his every manoeuvre, drove him steadily the other way, and got home burst after burst that ragged and tore at wings and tail, bursts that finally found an oil tank and battered it open in a sticky cloud.

"Fizzy," white-faced and flying with everything that was in him, realised that it was the end. He could only use his engine, now, for a matter of minutes. Then, if still in the air, he would be cold meat. From first to last he had never fired a burst from his own guns for fear that a chance bullet would wound one of his comrades.

And now, if he were still to avoid fighting back, there was only one thing for him to do. Jacko, for some reason, was stolidly forcing him away from the British side of the line.

"Damn," thought "Fizzy." "It's no good! I'll have to land on Fritz's side of the wall. I can't——"

"Fizzy" landed.

In one last movement he managed to stall in the midst of what looked like a roaring climb, so that Jacko shot too high and over-flew the mark. Before he could get his bearings again, "Fizzy" dropped the triplane like a stone. He swerved it low over the trench-lines, kicked over the rudder to avoid a gaping shell-hole which seemed to open like a mouth right in his path. Then, with the switch off, he brought down the tail.

But there was another shell-hole just beyond the first, and a second later what remained of the triplane was standing clean up on its nose in muddy water, whilst a half-drowned and spluttering "Fizzy" scrambled out, ducking to the whine of bullets.

He saw an open trench nearby, flung

himself on his face and wriggled towards it. Willing hands reached out and pulled him down, so that he fell with a thud on to the safety of a muddy floor. Then he looked up.

It would almost be correct to say that his eyes appeared to be starting out on stalks.

For he found himself staring up into the equally-amazed face of a British officer, backed up by a couple of real, brick-faced British Tommies.

"Gug—Gug——" spluttered "Fizzy" weakly.

Whereupon, with dramatic effect, he fainted.

A badly-punctured shoulder can have quite an alarming effect when left without attention.

### CHAPTER V A Matter of Direction

IT was in a dressing station that Captain Jackson eventually found him, after a succession of telephone messages which had made him wonder if he was dreaming.

"Fizzy" was sitting up and taking notice. Indeed, already he had recovered himself well enough to realise that he was really and truly on the British side of the map. And before Jacko arrived, he had told his story.

"Golly," said "Fizzy," "I muh—muh—must have missed my wa-way! Could have sworn I was being walloped down in Fritz's kennel. Talking of Fritz, there's a Big Bertha——"

The officers about him listened intently. Having heard his story and—by request, telephoned his aerodrome—they got on to Brigade. And Brigade communed deeply with certain Heavy Batteries, directing their attention to a wood east of La Bassee.

Captain Jackson arrived at the dressing-station before any kind of shoot started. As a matter of fact, the Heavy Battery, in the person of its commanding officer, was almost tearfully talking over the telephone with Brigade, and gesticulating with a map.

It was at about that time that Brigade

## VISIBILITY LOW

got in touch with R.F.C. Wing, with the object of sending a machine out over a wood beyond La Bassee, to contact long-range shelling. But Wing demurred. They became argumentative and started to refer to maps too.

In short, there was a serious hitch in the conduct of the war, when Captain Jackson arrived to stare at his neatly-bandaged subordinate, who was smoking a cigarette and grinning cheerfully over a bit of Fokker tail which an obliging Tommy had brought in as a souvenir.

"I ought to break your neck," said Captain Jackson. "I ought to have you shot at dawn for straying away from the rest of us like that, especially in mist. 'Fizzy,' you're an ass! And now tell me the whole story. I've already had a few kind words with Wing about it, and——"

Only too willingly, "Fizzy" spluttered into the stirring tale again. And as he finished he was bouncing with delight.

"After I'd found the Big Bertha and got away in that t-truck," he finished, "I saw you fellows popping-off home. So I followed. And even now I can't understand why you turned round and came back at me. I don't know how you could have seen me."

"We didn't," said Captain Jackson wearily. "Oh, good heavens, 'Fizzy,'—we weren't going home! We were chasing those Fokkers as far as we dared into Germany. It wasn't safe to go any further, so I turned the lads round. And you—you blind-eyed, fat-headed——"

"Oh!" gasped "Fizzy." "You w-w-weren't going——? Oh, golly, that ex-ex-explains it. That's how I got so mu-mu-mixed up, when I had to land. But I was pup-pup-puzzled the whole time. Those Huns were fri-fri-frightfully clever about that wood. I've never seen a w-w-wood east of La Bassee——"

"East of La Bassee?" echoed Jacko, with a sudden gleam in his eye. "Listen now, 'Fizzy,' are you trying to tell me that you were east of La Bassee when you dropped down and landed beside that wood you've been telling me about?"

"Wh-wh-why, yes," spluttered "Fizzy," but before he could say any-

thing else Captain Jackson had jumped to the telephone and called up Brigade. And after a conversation which brought perspiration glistening to his forehead, he at last got what seemed like sense from the other end of the wire.

"A mistake," bellowed Captain Jackson. "Yes, our pilot was a bit knocked-out when he was taken from the machine, and first told the story. He got mixed. The wood in question is immediately behind *Lens*! I know that because he was flying in my squadron when he dropped down and landed in the mist. There isn't any wood east of La Bassee! But the real one is behind *Lens*. Right? Yes—right!"

And panting and slightly dishevelled, he came back.

"You'll be the death of me," he said; "you——"

Suddenly he laughed. He dropped his head into his hands and laughed until the tears were staining his cheeks.

"Fizzy" looked at him at first in alarm and then with a touch of dignity.

IT was during that interim, indeed, that Brigade, Wing and the Heavy Battery at last reached agreement on Captain Jackson's new directions. A contact-patrol machine went off before the day finally faded. And as the first, long-range heavy shells began to arrive and wipe-out a certain wood, so that men had to dash for their lives amidst the ruins of the anti-aircraft guns, a bombing squadron hummed ponderously and slowly out of the west to finish off the job.

But Captain Jackson had, by then, only just recovered from his consuming mirth.

"Well, well, I won't spoil your fun now, 'Fizzy,'" he breathed. "You're a little tin hero with a bright brass button on top, and you'll probably get a decoration and a shrimp tea at Brigade H.Q. for this job. Meanwhile, the brass-hats at Wing want to have a heart-to-heart chat with you. You see you're the only man on this side of the war who's ever seen a Big Bertha close-to, and they want to know all you can tell them about it. So now get going, the doctor tells me you're fit enough to run about on your own.

## AIR STORIES

And the drinks'll be on you, my son, when you do get back to the aerodrome ! ”

“ Fizzy ” got going. With his head in the air, he left the dressing-station, jumped a lorry that was passing, and swung his legs in deep contentment from the tail-board, whilst Captain Jackson drove off in a Crossley tender in the opposite direction.

**B**UT Jacko had a harassing afternoon. An hour or so later he was called by Wing to the telephone, and sulphurously asked when he contemplated obeying orders and sending Lieutenant Low along ? For two hours after that Captain Jackson telephoned far and wide, and was repeatedly gingered up again by Wing, who were beginning to get really dangerous.

When the telephone bell rang for about the fortieth time, Jacko passed a trem-

bling hand across a damp forehead, and raised the instrument wearily. He braced himself for the fortieth choking-off.

He suddenly stiffened as he heard a distant voice come plaintively along the buzzing wires.

“ ‘ Fizzy, ’ ” he exploded, “ Low. Is that *you* ? What the devil ! Look here, where on earth—— ”

“ Th-th-thank Heaven that's you at last, Jug-Jacko ! ” came Lieutenant Victor Low's voice from out of the far, far away. “ I'm having an oppo-appo-appalling time ! Can't make anyone un-un-understand me, around here. It seems they are all Bub-Bub-Belgians. ”

“ Belgians ? ” gulped Captain Jackson weakly.

“ Belgian ah-ah-army, ” came back the plaintive reply. “ Jug-Jug-Jacko, I can't understand it, bu-but I seem to have lo-lo-lost my way. . . . ”

Here, for the first time, is the full and authentic story of the Imperial German Air Force during the Great War. Its birth, early struggles, victories and defeats and, most bitter of all, its final collapse and disbandment, are all faithfully recorded. For the most part, the men who filled its ranks and made its history will be seen to have been fearless, chivalrous fighters. Enemies though they were, they were a gallant company, the sky warriors of the Fatherland. To their dead, history will pay tribute ; to the living we say “ Soft Landings ” and “ *Hals und Bundbrucken* ” ; and to both we dedicate

## “WINGS OF THE BLACK EAGLE”

The Epic Story of the Birth of Germany's Air Power

Recorded by A. H. PRITCHARD

Many readers have written asking for the scores of various of Germany's 170 “ Aces ” ; hundreds of queries have been sent requiring information regarding Germany's war-time aircraft and air fighting tactics ; now, all this information is given in a year-by-year account of the meteoric rise of Germany's Air Power during the Great War.

DON'T MISS THE START OF THIS EPIC STORY  
IN NEXT MONTH'S “AIR STORIES”—ON SALE  
MAY 11th





Editorial Offices : 8-11 Southampton Street, Strand, London, W.C.2

**I**N a recent issue of AIR STORIES there was printed a story of war-time flying on the Western Front, written by a man whose nom-de-plume concealed the identity of an ex-R.F.C. pilot with a distinguished war record. In the course of that story, which was written as fiction, the author described a forced landing within the German lines, made by one of the principal characters, and his subsequent rescue by the pilot of another squadron who landed nearby.

An ex-R.F.C. officer, who has long since retired, happened to read this story and was so struck by the extraordinarily detailed similarity of this apparently fictitious incident to one which he had himself actually experienced in France that, through AIR STORIES, he got into touch with the author of the story. The "coincidence" was soon explained. The author, drawing on his own war-time experiences, had attributed to the character in his story a forced-landing which he himself had actually had to make in German territory; while the reader who had recognised the incident proved to be none other than the very pilot who had rescued the author (standing on the wing-root of an S.E. 5) after his forced landing. Both men had lost all trace of each other since the War, though each had been anxious to renew an acquaintance begun in so dramatic a manner.

Less remarkable have been the several

instances of former squadron mates being brought together again as the result of squadron histories and real-life reminiscences which have appeared on our pages, but the incident quoted above is of particular interest as evidence of the sound basis of fact underlying even the war flying fiction printed in AIR STORIES.

Incidentally, we are always pleased to forward letters from ex-R.F.C. readers who think they recognise real-life happenings in any of our air-war stories.

#### **Flying Faster than Bullets**

**JUDGING** by the large number of enquiries we receive every month, one of the most popular features of AIR STORIES is the service rendered by our Information Bureau in answering readers' aeronautical questions. Many hundreds of questions, dealing with every aspect of aviation, past, present and future, have been answered since the Department was first started, and, though we are inclined to suspect some readers of collecting "teasers" for the special purpose of confounding us, it is not often that our experts have to admit defeat.

We do not suspect Mr. F. Kite, of Ely, Cardiff, of any ulterior motive, but his recent query is typical of some of the curious problems we are asked to solve :

"The speed of a bullet," he writes, "is, I am told, some 300 m.p.h., whereas the world's air speed record stands at 440½ m.p.h. This being the case, would not an aeroplane capable of 400 m.p.h.,

## AIR STORIES

and fitted with machine-guns, catch up and pass its own bullets in flight—or would it?"

This problem is, in fact, a comparatively simple one—but for the benefit of those who wish to manipulate their slide-rules in its solution, we have deferred the answer to the foot of this page.

One recent query, however, which *has* baffled us, comes from Miss M. Wood, of Wallington, Surrey, who asks :

"Why were recruits called 'huns,' when this was a nickname for the Germans? I notice the expression frequently occurs in your war-air stories, and I should like to know its origin."

So should we. The term can hardly have originated as a reference to the ham-fistedness of the average flying pupil, as the general standard of flying in the Imperial German Air Service was second only to our own, and to say that a man "flew like a Hun" would be more complimentary than insulting. True, instructors' lives were often exposed to greater danger by the antics of clumsy pupils than by German bullets, but, even so, pupils surely did not kill themselves or their instructors on a sufficiently grand scale to justify being called "Huns" for that reason. Perhaps some of our readers can give us the true origin of this nickname?

### What Do You Think?

A REQUEST similar to several we have recently received from readers is voiced by Mr. R. Heygate, of King's Lynn. He writes :

"Don't you think that a News Section might usefully be added to AIR STORIES? It would only need a page or two—one short story might be omitted to make room for it—and it could give the latest news of record flights, new aircraft, inventions and, perhaps, brief articles on learning to fly, aerodynamics, etc."

Our own view on this question is that these subjects are fully dealt with by the

### AEROPLANE v. BULLET

*Whatever the speed of an aeroplane, it could never catch up with its own bullet. When fired from a moving platform, a bullet adds to its own normal speed the momentum of its platform. Thus, if we assume that  $x$  = the speed of the bullet and  $y$  = the speed of the aeroplane, then the speed of the bullet when fired would be  $x + y$ ; hence the speed of  $y$  could never equal  $x + y$*

various technical and semi-technical aeronautical journals in this country, and that the great majority of our readers prefer that AIR STORIES should be exclusively devoted to stories and articles of a kind which do not appear elsewhere. If we are wrong in our opinion, we have no doubt that our readers will speedily write and point out the error of our ways.

### Bouquet and Brickbat

A LARGE brickbat—nicely wrapped up in a bouquet—comes from Mr. P. C. Birch, of Brough, E. Yorks. He writes :

"For heaven's sake stop the so-called model section! There are a thousand and one magazines on the market catering for modellers without AIR STORIES joining them. By all means include the plans and scale drawings—I have built 37 scale, semi-scale, solid and flying models—but don't ramble on through half a dozen pages giving information that any sane individual can discover for himself from the drawings.

"Your magazine is the FINEST STORY MAGAZINE about aircraft on the market, with none of that lurid, cheap tripe. Let it remain a STORY magazine and not deteriorate into a common or garden encyclopædia. I work at an aircraft firm and like to come in after work and enjoy a good story, not to be told how to sharpen a penknife!"

That's plain speaking, that is—and we like it. All the same, our correspondent is rather exaggerating the space occupied by our much-discussed model section and, an expert modeller himself, is apt to forget that many new readers buy AIR STORIES each month and are unfamiliar with the rudiments of model-building. Hence the necessity for a certain amount of repetition in the instructions, which, however, never occupy more than a total of three pages in any issue. We like the "bouquet," too, and can assure Mr. Birch that the magazine will always remain primarily a STORY magazine (in capitals!).

### News for Next Month

NEXT month's issue will be noteworthy for the start of a great new air-war historical article by A. H. Pritchard. Entitled "Wings of the Black Eagle," it gives the most graphic and detailed account of the War in the Air, as waged from "the other side" of the Lines, that has yet been published, and will prove of absorbing interest to all students of aerial warfare.



*A Crime Book-Society  
Recommendation*

# JOHN CREASEY'S international thriller **THUNDER IN EUROPE**

Author of "Death round the Corner,"  
"The Mark of the Crescent," etc.

Few authors can maintain the break-neck pace of Mr. John Creasey's thrillers, and his Department 'Z' is a well-established and popular institution with a wide circle of readers. "Thunder in Europe" will enhance his reputation without question.

This remarkable story is made up of a succession of hair-raising thrills, culminating in the most gripping climax Mr. Creasey has yet conceived.

7s. 6d. net.

**ANDREW MELROSE LTD.**

**BLUSHING.** —FREE to all sufferers, particulars of a proved home treatment that quickly removes all embarrassment, and permanently cures blushing and flushing of the face and neck. Enclose stamp to **Mr. S. TEMPLE, Specialist, Palace House, 128 Shaftesbury Avenue, (2nd Floor), LONDON, W.1. Est. 30 years.**

## HAVE YOU A RED NOSE ?

Send a stamp, and you will learn how to rid yourself of such a terrible affliction free of charge. *Address in confidence.*—**R. TEMPLE, Specialist, "Palace House," 128 Shaftesbury Avenue, LONDON, W.1. (Est. 30 years.)**

**WHEN REPLYING**

**TO ADVERTISERS**

**KINDLY MENTION**

**"AIR STORIES"**

# Are Your EYES Weak



If so, let us send you FREE our interesting book on "EYES" that gives complete advice upon how to strengthen and preserve the most WONDERFUL ORGAN OF THE HUMAN BODY. It shows how you can cure most defects without spectacles, drugs, or operations. All these admitted failures are superseded by the "Neu-Vita" System that successfully helps nature to strengthen the eyes and restore the vision. A safe mode of self-massage that gently stimulates the eyes by restoring the vital blood circulation—that is all your weak eyes need. For refractive errors—as Near-Sight, Far-Sight, Astigmatism, Squint, etc.. due to eyeball distortion—the eye is moulded painlessly yet surely to normal shape. Five minutes easy self-home treatment wonderfully strengthens the eyes, counteracts eye-strain, cures headache, corrects most eye troubles, and enables glasses to be discarded for good. Have faith in nature. Animals don't need spectacles; neither need humans.

### SEE NATURALLY

#### Throw Away Your Eyeglasses.

To spread eye knowledge the book (published price 1s.) is distributed freely at cost. Secure your FREE COPY now by sending 3d. (abroad, 6 foreign) stamps. Send no money or postcards. Simply enclose stamps, with full name and address to:

**NEU-VITA (Dept. J.T. 28)  
176-252 Central Buildings, London Bridge,  
London, S.E.1. England.**

# Romance of the Wonder Ship "QUEEN MARY"

MAGNIFICENT PICTORIAL  
SOUVENIR OF THE WORLD'S  
GREATEST LINER

"THE STORY OF R.M.S. QUEEN MARY" is a stirring pen-picture which takes you round Britain's monster ship as though you were sight-seeing with a guide. There is romance in every line, in every page, in every thrilling photograph. It is a romance of industry and endeavour that you will read again and again.

**Get Your Copy NOW! 6D.**  
On Sale Everywhere



## WHAT GIVES A GORILLA THE STRENGTH OF 10 MEN

**R**EAD the most sensational book on strength ever published. This book will amaze you with its facts—startle you with its possibilities. You don't know you're alive until you get this book in your own hands. Do you know what gives a gorilla the strength of 10 men? Do you know why strength and virility are connected? It will answer questions you have hardly dared to ask yourself, and you can get a copy **FREE**—if you hurry. Fill in the Coupon **NOW**, this minute, and post it **TO-DAY**.

## WHAT THIS AMAZING BOOK TELLS YOU!

- How to Add Inches to Your Chest.
- How to Strengthen Your Back.
- How to Treble Your Strength.
- How to Get Strong Nerves.
- How to Get Great Strength.
- How to Develop a Muscular Body.
- How to Cultivate Personality.
- How to be Successful.
- How to Attract Friends.
- How to do Feats of Strength.
- How to be Always Well.
- How to Get Endless Endurance.

POST THIS COUPON TO-DAY

**ALFRED J. BRITON (Dept. A.S.)**  
8 Broadway,  
London, W.6.

Name .....

Address .....

.....May



Fraser Field offers you his **AMAZING BOOK FREE.**

## STOP BEING SHY!

**A**RE you nervous, self-conscious, shy? Do you blush, feel ill at ease when talking to strangers? **NOW** you can quickly banish these fears—you can be the person you **WANT** to be!

## I'LL GIVE YOU DETERMINED COURAGE—IN 36 HOURS!

**H**UNDREDS of people are not themselves—lead unhappy lives, because they allow nervousness, fear of criticism, shyness and other fears to blight their lives. Yet fears of the future, fears of themselves, fears of the opposite sex and superiors is absolutely unnecessary! If you suffer in this way you can apply a simple method that instantly gives relief. There is no inconvenience, you won't have to wait for results—at once you will feel the benefit and within 36 hours your fears will be gone! Send for this book now, you will be astonished!

## WHAT THIS AMAZING BOOK WILL TELL YOU!

- HOW TO OVERCOME SHYNESS.
- HOW TO CURE SELF-CONSCIOUSNESS.
- HOW TO KILL FEAR.
- HOW TO SPEAK WITHOUT TIMIDITY.
- HOW TO MASTER AWKWARD SITUATIONS.
- HOW TO EXERT YOUR AUTHORITY.
- HOW TO GET DETERMINED NEW COURAGE.
- HOW TO STRENGTHEN THE WILL.
- HOW TO CURE A BAD MEMORY.
- HOW TO INFLUENCE OTHERS.
- HOW TO BANISH BLUSHING AND NERVOUSNESS.
- HOW TO GET STRONG NERVES.

## FREE!—IF YOU HURRY!

Send for my fully illustrated **FREE BOOK**. This book will show you how to banish all forms of nervousness. A few copies are being offered free. Send the coupon at once!

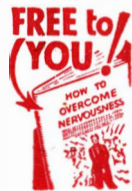

## FRASER FIELD (Dept. A.S.),

The Broadway, Hammersmith, LONDON.

Please send me at once, free and without obligation a copy of your new book, "How to Overcome Nervousness," in plain wrapper

Name .....

Address .....

.....May